

Statement-based Cost Estimate for Co-utilization of Service Facilities

HIDENORI KAWAMURA^{1,a)} RYOTA ONO¹ KEIJI SUZUKI¹

Received: July 6, 2013, Accepted: January 8, 2014

Abstract: In this paper, we focus on allocating of social service facilities which are operated under the first-come-first-serve rule. In such facilities, users cannot make a reservation in advance. To reduce congestion, it is desirable to adjust a schedule by communication devices. We propose the user-in-the-loop forecasting with the statement-based cost estimate, and apply to two types of facility allocation models, i.e., the theme park scenario and the highway scenario. The computer experiments show that the proposed estimate caused better results in both scenarios to reduce congestion. In particular, the users in the highway scenario could achieve a near user equilibrium situation without any advance experience of the system.

Keywords: user-in-the-loop forecasting, statement-based cost estimate, multiagent systems, traffic systems, resource allocation problems

1. Introduction

Recent progress in information technology related to cellular phones and car navigation systems have enabled to develop new types of services on a communication network. As one of such service applications, we focus on the application for utilization of socially shared service facilities. The service facilities, in this paper, mean “first-come-first-served” facilities for any demands, and basically nobody can book them in advance. The examples of these facilities include roads or highways in a traffic system, attractions in a theme park, public transportation and parking lots. Although we are aware that recently some of these facilities provide a kind of reservation service, we do not focus on reservation which possibly grows the idle time of facilities.

One of the important problems in service facility allocation is that over capacity users often make a long queue. The waiting time in a queue is really a waste of time, and it is especially serious in a traffic system. If they can adjust their schedules in advance, they may avoid over-concentrating to the facilities. However, the users often demand some facilities with individual constraints, and an independent optimization is difficult. On behalf of the protection of the environment, the prevention of over-concentration not only promotes the effective use of existing facilities but enables new developing facilities to be downsized. To promote the effective use of facilities, we have tried to design a planning system to coordinate the co-utilization of service facilities among users.

This problem is a kind of resource allocation problems, and Kurumatani has proposed the concept of “mass user support” to tackle this type of problem [10]. The goal of mass user support is

not only to optimize the individual utility but also to support a social system comprised of a group of individuals. Our application is one of mass user support systems.

One important issue to construct such a planning system is how to let users follow the system planning without reservation. The users should be treated fairly with the guarantee of individual free will, and it is not permitted to compel users to follow the system, even if the system tries to enhance not only social welfare but individual utility. This issue is a matter of game theory but it is not easy to analyze by a usual game-theoretic approach. Thus, we have to analyze the problem by empirical game-theoretic approach [19].

Another issue is how to estimate an uncertain future situation for individual planning. One of the simplest ideas is to utilize current congestion information and recommend users to avoid congested facilities. Some researchers have investigated the effectiveness of such current congestion information. Kawamura and Suzuki made multiagent models to simulate the visiting behavior of users in a theme park and event-hall, respectively [6], [15]. Mahmassani, Shiose, Yamashita, Yhoshii and Whale made traffic simulation models individually and they analyzed the effectiveness of the current congestion information [11], [14], [16], [20], [21], [22]. Arnott also analyzed the effectiveness of such information with a theoretical traffic model [1]. Fischer investigated the behavior of selfish agents in a routing problem [5].

These researches basically reached the same conclusion that the simple utilization of current congestion information does not cause good effect. This is because that the current information depends on only the current situation and it becomes unavailable when the user arrives at a facility in future. Such unavailability causes the temporal and spatial oscillation of facility demand, then, the total performance is spoiled by these influences.

Another idea is to implement some kind of congestion fore-

¹ Graduate School of Information Science and Technology, Hokkaido University, Sapporo, Hokkaido 060–0814, Japan

^{a)} kawamura@complex.ist.hokudai.ac.jp

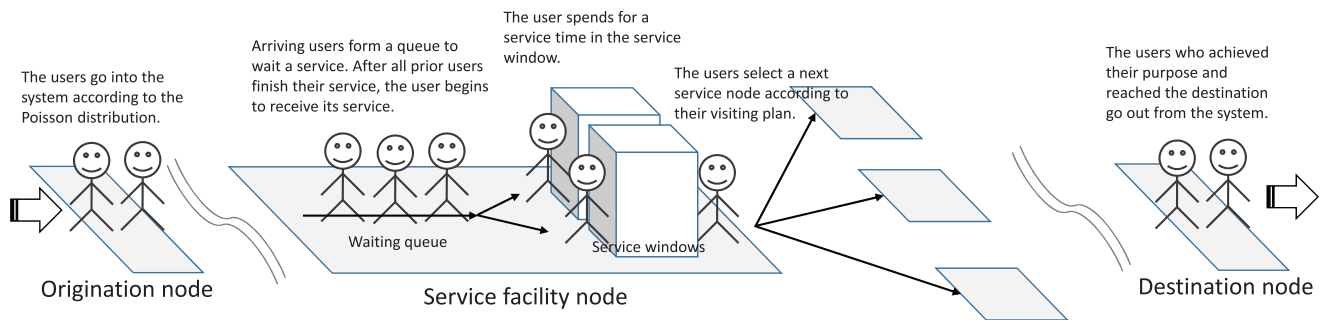

Fig. 1 The outline of proposed simulation model.

casting. However, the forecasting from outside of the system may not be effective because the forecasted congestion information directly affects the user behavior and it makes the future situation different by the effect of its forecasting. Thus, we have an assumption that the “user-in-the-loop” forecasting system is necessary, in which the user planning and congestion forecasting are connected each other to form the right feedback loop. Yamashita and Yoshii have introduced a primitive version of such an idea to traffic models [20], [21], and we are developing a more general and practical theory for a facility co-utilization.

In this paper, we show the first idea of the user-in-the-loop forecasting and planning system for service facility allocation, and we propose the statement-based cost estimate for realizing the system. This paper is organized as follows. Section 2 describes a user-facility model and two experimental scenarios. In Section 3, we explain the user planning and cost estimate. Section 4 shows some experimental results, and we discuss in Section 5. Finally, we conclude our paper in Section 6.

2. Simulation Model

2.1 Environments

Service facilities and transiting users among these facilities constitute our simulation model (see Fig. 1). The simulation runs along simulation time t until t reaches the maximum time t_{max} . The users behave once in turn at each time t , and t is incremented by one after all the users behave.

A service facility, which provides users a kind of service under the first-come-first-served rule, is represented as a node. The nodes are connected by directed links, and these nodes and links constitute a graph network. The set of directed links regulate the users' possible transition paths between the nodes. Node i on the network has two given parameters, the number of service windows, w_i and the service time, s_i .

The service facility in node i can serve the number of w_i users simultaneously, and a user who begins to be served on node i has to spend the time s_i to pass to a next node. Usually, w_i is set to a finite number and the facility in node i is strictly operated for the number of w_i users under the first-come-first-served rule. Otherwise, w_i can be set as “infinity” and it defines that node i has an unlimited service window, then it can serve all visiting users immediately and simultaneously. Over-capacity users have to wait in a queue, and the number of users queuing up on node i is denoted by $queue_i$.

The users appear at each time t according to the Poisson distri-

bution until the total number of users reaches the maximum number N . The arrival rate of the Poisson distribution is denoted by λ . Each of the users departs an origination node and goes toward a destination node through some facility nodes on the network. In some experimental scenarios the users have to visit some given facilities as constraints. The users individually aim to minimize the travel time which is the difference between the departing time from the origination and the arrival time to the destination.

Each user has a plan which consists of a sequence of nodes the user intends to visit during its travel. It guides which node the user should go to next. The plan of user j is denoted by $plan_j$, and how to decide $plan_j$ is the main interest of this paper. Our idea is described in the next section.

When arriving at a new node, the user has to join a queue list to wait for its turn. After all prior users in the queue finish their service, the user begins to receive its service. If there is no prior user in the queue list, the user immediately enters into its service. The user who has just finished receiving its service chooses a next node from ones linked by the current node.

Because the waiting time in a queue depends on the number of prior queuing up users, the total travel time of the user depends on the other users' behavior. In other words, the travel time of users is interconnected through mutual travel plans and cannot be optimized individually. The total objective of this problem is to find a better coordinating way to minimize the average travel time of whole users.

For a more algorithmic description of the user behavior, let user j be introduced the status parameter, $status_j$ and the current position, $position_j$. $status_j$ takes one value in status $\{inactive, waiting, served, terminated\}$. At the beginning of simulation, $status_j$ and $position_j$ are set to *inactive* and an origination node, respectively. At each time t , $status_j$ and $position_j$ are switched, according to the pseudocode in Fig. 2. The travel time of user j is calculated when the user status reaches *inactive*.

2.2 Experimental Scenarios

We introduce two experimental scenarios as a bench mark, i.e., the theme park scenario and the highway scenario. For choosing experimental scenarios, we focus on two constraint types of visiting service facilities. In the first constraint type, it is corresponding to the theme park scenario, the user is given the service facilities in advance that he/she has to visit, and decides the order of visit to reduce the travel time like Traveling Salesman Problem. In the second constraint type, it is corresponding to the highway

```

switch (statusj)
case "inactive":
    if user j appears at an origination node
        start_timej ← t;
        positionj ← the next node indicated by planj;
        statusj ← waiting;
        break;

case "waiting":
    if the current facility becomes ready to serve user j
        statusj ← served;
        remaining_timej ← S(positionj);
        break;

case "served":
    remaining_timej ← remaining_timej - 1;
    if remaining_timej = 0
        positionj ← the next node indicated by planj;
        if positionj is a destination
            end_timej ← t;
            travel_timej ← end_timej - start_timej;
            statusj ← terminated;
        else
            statusj ← waiting;
            break;

case "terminated":
    break;
    
```

Fig. 2 Pseudocode of status transition.

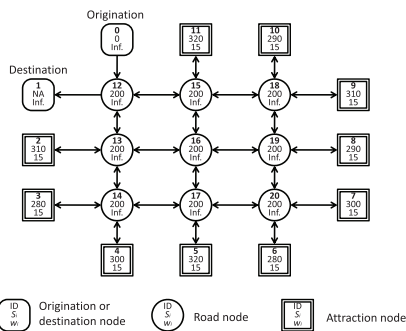

Fig. 3 The network model of the theme park scenario. Each user arrives at the origination node 0, visits randomly given 4 attractions through road nodes, and finally goes to destination node 1.

scenario, the user is given the origination and the destination in advance, and has some alternative ways to reach the destination. The choice of the alternative affects the travel time. The combination of such types of constraints can represent various conditions of utilizing service facilities and we firstly investigate these scenarios as a bench mark.

Theme park scenario

This scenario consists of an origination node, a destination node, attraction nodes and road nodes (see Fig. 3). Each visitor user coming to the theme park starts from the origination node and goes toward the destination node through randomly given four attraction nodes. “Randomly given” means that the users have the four attractions most to their taste and these are randomly defined. The user has to visit every given attraction just once in the travel. The road nodes bridge those nodes by enough throughputs with an unlimited service window. The microscopical motivation of each user is toward optimizing a permutation of visited attractions, while we would tackle globally balancing the load of the attractions.

In this setting, the attractions have some different service time,

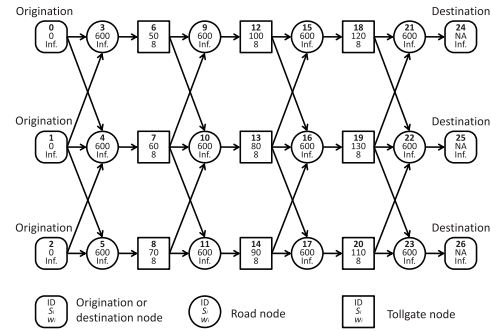

Fig. 4 The network model of the highway scenario. Each user starts from a randomly selected origination node from three ones. The destination is also randomly given from three destination ones in advance. There are four user choosing points neighboring to tollgates.

which causes the difficulty in balancing the load of the attractions. The topological characteristic, i.e., the distance from the origination or destination to each attraction, also causes the difficulty in consideration of estimating the total moving time and avoiding congestion at the attractions.

We are concerned in this model with investigating the characteristic of dynamic service facility allocation rather than developing a real application to an actual theme park or amusement park. This model can be positioned as one of typical service facility allocation problems in related works that have revealed the relationship between a user visiting behavior and information broadcasting in a congested space [6], [7], [12], [13], [15]. This model can be extended to a more complex simulation or combinatorial optimization problems by introducing complementarity, substitutability or order constraints of facilities.

Highway scenario

In this scenario, there are three highway lanes connecting from three origination nodes and three destination nodes (see Fig. 4). Highway users depart off a randomly selected origination node and head for a destination node also randomly selected. Each lane, which is one-way, consists of several pairs of a road node and a tollgate node. The road node, which bridges tollgate nodes by one-way links, demands the users some time to pass through. The tollgate node is supposed as one of the abstract source of traffic jam and each of those nodes has a different service time. The user can switch the lane through the connection links to avoid a traffic jam. The global purpose in this scenario is to achieve a user equilibrium situation [17], one ideal situation in traffic systems, in which each user can not find any better route than the current one they individually optimized.

Some related works in traffic researches theoretically or analytically investigate similar scenarios with several one-way lanes highway and commuters [9], [11], [16]. Although those researches use more sophisticated traffic models, e.g., a Greenshield’s V-K model or a cellular automata model, we have adopted this queuing model for the sake of simplification. We believe a method solving this simple model could be applied to other models by a little extension. In addition, some researches in resource allocation suppose that the users have a perfect rationality or learnability in a repeatable situation [1], [2], [5], [8], [9], but our target is to construct a more realistic way to achieve a globally optimized situation without such an assumption.

3. User Planning

3.1 Plan Search

For the construction of a user planning process, we suppose submissive users in the simulation. The indication by sufficiently optimized plans is enough to keep an incentive for users to follow the plans. In other words, if we can produce the system with a very effective individual planning, there is no incentive of the user to refuse its plan and it is unnecessary to compel the users to follow such plans.

In the simulation, the planning of each user is carried out at the beginning of the user activity on the origination node and every planning interval, which is denoted by $interval_j$. The planning process of the user is independent with other users, therefore, the whole planning is asynchronously distributed among all participating users.

The plan for user j , $plan_j$ consists of a sequence of nodes, and this sequence is constrained to start from the current position and complete at the destination node through some connecting nodes. Let $node_j^k$ denote the k -th node which user j intends to visit in $plan_j$. The scheduled time to visit the k -th node in $plan_j$ is denoted by $time_j^k$ and defined as follows.

$$\begin{aligned} time_j^k &= t, k = 1. \\ time_j^k &= time_j^{k-1} \\ &+ cost_{(node_j^{k-1})}(time_j^{k-1}), k \geq 2. \end{aligned} \quad (1)$$

Where, the notation $cost_i(t^*)$ represents the estimated required time to pass node i at current or future time t^* . We suppose the users inquire such a cost to a central cost information server which watches the queue lists and provides the cost information to demanding users. The estimated travel time, namely the evaluation of $plan_j$, is obtained as the last $time_j^k$ to reach the destination. The objective of planning is to find $plan_j$ which minimizes the estimated travel time but it is not always a correct estimation for the future situation. The cost estimate is described later.

This optimization problem in our model is the combination of two problems, a permutation problem and a shortest path problem. For example, in the highway scenario, the user does not have any stop point and expects to arrive at a destination node as soon as possible. This is actually the shortest path problem to find the shortest path from a current node to the destination node in the highway network. On the other hand, in the theme park scenario, the user has to go toward a destination through some given attraction nodes every once in a plan. It is considered as the combination problem to find an order of attractions and the shortest path connecting these attractions.

To make a plan, the combination of a simple local search and Dijkstra's algorithm [3] is implemented in each user. At the first step of planning, a random order of not-visited attractions is generated. Then, Dijkstra's algorithm makes a shortest path connecting to the current position to the destination through these attractions following the order. If there are some same cost paths, one of these is randomly chosen. The shortest path corresponds with a sequence of nodes on the network. This sequence is kept as the initial candidate plan. If the user has no stop point like in

the highway scenario, Dijkstra's algorithm simply connects the current position to the destination.

The travel time of the plan is estimated by Eq. (1). After estimating the candidate plan, a neighbor plan is generated by randomly exchanging an order of two stop-points in the candidate plan, and these are connected by the Dijkstra's algorithm again. If the neighbor plan excels the candidate one, it replaces the candidate plan; otherwise, the candidate plan is kept as it is. The generating and replacing process is repeated until replacement has not occurred for the pre-defined number of times. As default setting we chose 15 times as the pre-defined number because in the theme park scenario each user does not have many visited attractions and the search space is small enough. The final candidate plan is accepted as a formal plan to indicate the user a next node to go.

The above process would cause a good effect if an accurate future cost estimate is possible, but it is not so easy. The actual behavior of a queue list in each facility is an aggregate phenomenon by not only one user but all other users activities. In other words, the actual, not estimated, travel time of each user is interconnected with other users, some of whom are moving on the network, and others do not appear yet. Thus, how to estimate the cost in a future situation is the most important key to resolve the dynamic service facility allocation problem.

To construct the cost estimate, we can pick up some options, i.e., the static or current information-based cost estimate and a kind of forecasting cost estimate. The static information-based cost estimate utilizes a static characteristic of a system, e.g., a usual car navigation system calculates the shortest route based on a geographical road map. This estimate is not linked to other users' behavior and could work well in a non-congested system. In our simulation, the users based on such estimate always utilize service facilities by a usual way with disregarding congestion and their behavior merely spoils a part of a facility capacity. Thus, we are not concerned with the current information-based cost estimate users. Some forecasting cost estimate from the outside of the system utilizes historical data in many trials, and such an estimate also causes the similar effect of static information case. That estimate is possibly effective in the long term load balancing but we are not concerned with such a long term effect because we suppose in this paper that the same situation does not repeat.

We focus on two ways, one is the current cost estimate (CCE) as one of typical congestion information, and another is the statement-based cost estimate (SCE). The statement-based cost estimate is the main idea for the user-in-the-loop forecasting and we expect it to form the right feedback to reduce an undesirable unbalance and oscillation in the utilization of congested facilities.

3.2 Current Cost Estimate (CCE)

CCE is simply based on the current situation of each facility. The cost of facility i at future time $t^* (> t)$ is calculated with only the current number of queue list.

$$cost_i(t^*) = (queue_i/w_i + 1) \cdot s_i + 1. \quad (2)$$

In the case w_i is set to be unlimited it is simply equivalent to $(s_i + 1)$. This cost is an approximated value rather than an exact

one even if the user arrives at the facility i immediately. Because of that this cost does not take into account the timing when currently served users go out. A more exact current cost estimate could be built with the inclusion of such timing but we are not concerned with it here for simplicity.

In the case $t^* = t$, the facility i equals to $position_j$, and $cost_i(t^*)$ means the estimated remaining time to complete the service in the current facility. It is estimated as follows.

$$cost_i(t^*) = \begin{cases} remaining_time_j & \text{if } j \text{ is in service,} \\ (pqueue_i/w_i + 1) \cdot s_i + 1 & \text{otherwise.} \end{cases} \quad (3)$$

Where, $pqueue_i$ represents the number of prior queuing users against user j in the queue list of facility i .

3.3 Statement-based Cost Estimate (SCE)

The following description starts from just after a user decides a plan because the SCE runs on a cyclic process between planning and cost estimation. We focus on $plan_k$ which contains the sequence of pairs of $node_j^k$ and $time_j^k$. When the plan is fixed, it is also fixed when user j intends to arrive at each node included in the plan. Based on this schedule, the set of “statements,” each of which represents the potential timing of a user arrival, is generated.

$$statement_j(i, t^*) = \begin{cases} 1 & \text{if } \exists k, t^* = time_j^k, \\ 0 & \text{otherwise.} \end{cases} \quad (4)$$

In other words, $statement_j(i, t^*)$ takes 1 if user j intends to arrive node j at the future time t^* ; otherwise, it takes 0. These statements are uncertainly tentative and the user can change the plan anytime but the aggregation of these statements becomes an effective information to harness the whole load balance. After deciding a plan, these statements are sent to the central cost information server.

Next, the number of potential users which are scheduled to join the queue at node i in the time range $[t, t^*]$ is defined.

$$num_i(t^*) = queue_i + \sum_{T=t}^{t^*} \sum_j statement_j(i, T). \quad (5)$$

We suppose that there are the number of $num_i(t^*)$ prior users against the user who intends to arrive at time t^* and the user can start being served after their service. Node i is statistically expected to deal with the number of $(t^* - t) \cdot w_i/s_i$ users for time $(t^* - t)$, and the expected queue number at time t^* is defined as follows.

$$queue_i^*(t^*) = \max [0, num_i(t^*) - (t^* - t) \cdot w_i/s_i]. \quad (6)$$

The SCE at time $t^*(> t)$ can be defined by replacing the current queue length to the expected length in Eq. (2).

$$cost_i(t^*) = (queue_i^*(t^*)/w_i + 1) \cdot s_i + 1. \quad (7)$$

This is also equivalent to $(s_i + 1)$ if w_i is set to unlimited. In the case $t^* = t$ it takes the same manner in Eq. (3).

The SCE synchronizes with the aggregation of user plans and it can harness the users to avoid congestion. Each user can optimize and change its own plan individually, and that change is rightly reflected to the cost estimate in the central server. We call this process the user-in-the-loop forecasting with the SCE.

4. Computer Experiments

4.1 Setting

For computer experiments, we prepared the combination of the two scenarios (see Figs. 3 and 4 again) and the two cost estimate ways. We denote the theme park scenario and the highway scenario by the symbols “T” and “H,” and the CCE and the SCE by the symbols “C” and “S”, respectively. There are four experimental settings, i.e., “TC,” “TS,” “HC” and “HS.” In addition, we introduced five types of user appearance density, $(N, \lambda) = (1,000, 0.1), (2,000, 0.2), (3,000, 0.3), (4,000, 0.4), (5,000, 0.5)$, to each setting, since the density of users is the key factor to cause congestion on the facility network. In these settings, all the users have appeared until about $t = 10,000$. The capacity of facilities is large enough to deal with all the users for the case $N = 1,000$ and a congestion could not occur in such a case. On the other hand, a congestion could emerge on every facility in the case $N = 5,000$. The combination of setting and density is denoted like TC-1000, TC-2000, ..., HS-5000. The planning interval $interval_j$ is set to 300 in each case, according to preliminary experiments. The maximum time t_{max} is set to 40,000 and all the users have sufficiently finished their activity until this time.

4.2 Experiment 1

In experiment 1, the simulation was run 50 times per a setting. **Tables 1** and **2** show the average travel time and its standard deviation in the simulation results. In addition, the instance transitions of queue lengths in the settings TC, TS, HS and HC-3000 are depicted in **Fig. 5**.

First, we focus on the results of the theme park scenario. The averaged travel time takes a similar value in the both cases of TC-1000 and TS-1000. The facilities in these cases have enough capacity to deal with all the users and there is no much accumulative queue list. Both cost estimates do not make a difference in

Table 1 The performance comparison with two cost estimate ways in the theme park scenario. In each TC or TS cell, the upper amount is the average travel time, and the lower is the standard deviation. Each ratio cell shows the ratio of the average travel time in TC and TS cases.

	1000	2000	3000	4000	5000
TC-	4,065.8 (20.5)	8,043.3 (159.3)	14,001.1 (151.2)	20,270.2 (160.4)	26,691.2 (177.0)
TS-	4,063.2 (11.3)	7,862.5 (204.0)	13,308.5 (232.7)	18,816.6 (263.8)	24,210.2 (348.0)
Ratio (TS/TC)	99.94%	97.75%	95.05%	92.83%	90.70%

Table 2 The performance comparison with two cost estimate ways in the highway scenario. In each HC or HS cell, the upper amount is the average travel time, and the lower is the standard deviation. Each ratio cell shows the ratio of the average travel time in HC and HS cases.

	1000	2000	3000	4000	5000
HC-	2,694.5 (9.3)	3,542.7 (69.0)	5,712.1 (147.2)	8,145.5 (104.4)	10,671.2 (118.8)
HS-	2,681.4 (3.4)	2,848.0 (94.8)	5,277.8 (99.6)	7,738.6 (74.5)	10,236.2 (70.8)
Ratio (HS/HC)	99.51%	80.39%	92.40%	95.01%	95.92%

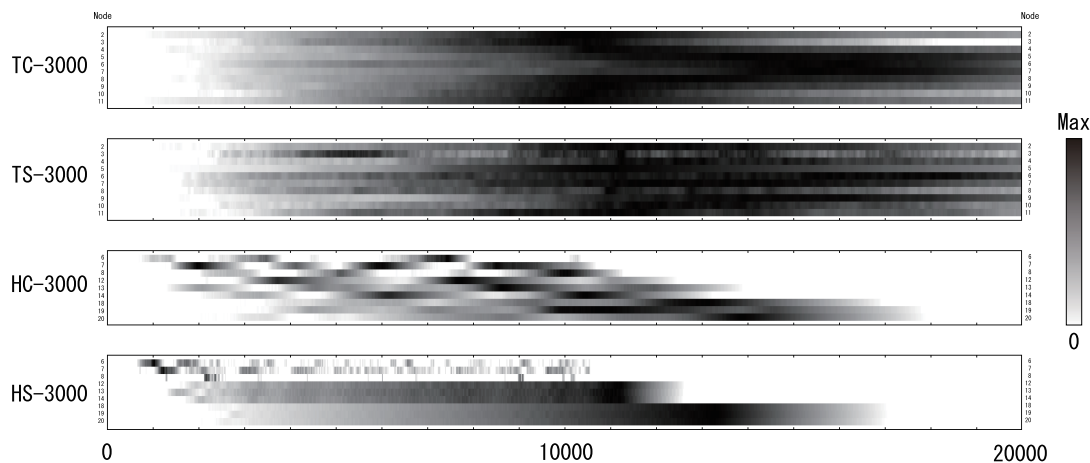

Fig. 5 The example transition of queue length in each facility. The horizontal indicates the simulation time [0, 20000]. Each line corresponds to the indicated facility node. The light and shade represent the normalized length of queue, which is divided by the observed maximum queue length in each queue.

the travel time. On the other hand, the increase of N makes TS results better than TC. For example, in the case of $N = 5,000$, the planning with the SCE can save about 9.3% of the travel time against the CCE.

The difference of queuing behavior is shown in Fig. 5. All simulations exhibited similar characteristics of queue length fluctuation in each setting, and the figure is drawn with a set of single simulations in each setting. In the theme park scenario, the user with the CCE does not take into account the current congestion. It is because the remaining attractions of the user at an instant are fixed and the total waiting time of the remaining attractions takes the same value in any plan under the CCE. Thus, the user of TC tries to optimize a plan ignoring the current congestion, and prefers to visit the attractions close to the origination node, gradually further ones, and the ones close to the destination in turn.

See Fig. 5, and the transition of queue lengths in TC-3000 indicates that the queue lengths of the attraction close to the origination or destination nodes, i.e., nodes 2, 3, 10 and 11, take a larger density at an early stage of the simulation, while the queue lengths of further attractions, i.e., nodes 5, 6, 7 and 8, take a peak in a little later time. The temporal difference of taking a peak causes temporal unbalance of the facility demand. On the other hand, the user of TS-3000 can temporally optimize a plan with consideration of future congestion, and the load of each attraction depends on the service time setting rather than the topological setting. This is the reason that the user of TS-3000 takes a better performance than TC-3000.

Next, we focus on the results of the highway scenario. The result in the case of $N = 1,000$ is similar with the theme park scenario, but in the case of $N = 2,000$ the user of HS shows the highest performance against HC. In this case, the SCE can save about 19.4% of the travel time against the CCE. The user flow around the density of $N = 2,000$ could be the critical point of congestion in which little difference of flow control makes a large difference of the travel time. The SCE in $N = 5,000$ saves only about 4.0% of the travel time against the CCE, however, it saves the largest total travel time of all the users than other cases.

See Fig. 5 again, and we can confirm the large difference between queuing behavior of HC-3000 and HS-3000. The user in HC-3000 tries to avoid congestion and selects a tollgate which is estimated to have less waiting time than others. The selecting user has to spend a while on a road node to reach the tollgate. For some time, successive users refer to the almost same cost as the former, and they cluster to go to the same tollgate. The effect of this clustering emerges later, and this time delay causes an oscillation of queue lengths as shown in Fig. 5. It spoils the performance of the CCE. On the other hand, the SCE can successively harness users flow based on a forecasted future situation, and the users flow smoothly adapts to the traffic load. In the HS-3000 case, each tollgate is equally congested at any time, and that is the most effective way to use this type of structure.

4.3 Experiment 2

We cannot compel users to follow an indicated plan even if the plan contributes to reduce not only the individual travel time but the total one. Keeping the incentive to behave along the plan is one of the most important matters to manage this type of system. It is desirable that the indicated plan is the best one than any other potential plans like a best response in game theory. However, it is not easy to find the best plan because the user cannot observe an entire payoff matrix in advance and merely can know the consequence of its own behavior. The SCE tries to draw a part of the payoff matrix in progress for the users who believe the SCE.

To investigate the optimality of an individual plan by the SCE, we carried out another simulation with TC, TS, HC, and HS-3000, in which the simulation of the plan of a randomly selected user is replaced by a random one without changing any other situation. In the TC/TS-3000 case, a random plan means a plan which consists of a random sequence of given attractions and shortest paths connecting these attractions by the Dijkstra's algorithm. There are $4! = 24$ possible patterns of attraction orders for each user, and one pattern is randomly picked up as a random plan. In the HS/HC-3000 case, a random plan is constrained to start from a given origination node and reach to a given destination node. We run 200 trials of the simulation for each setting and

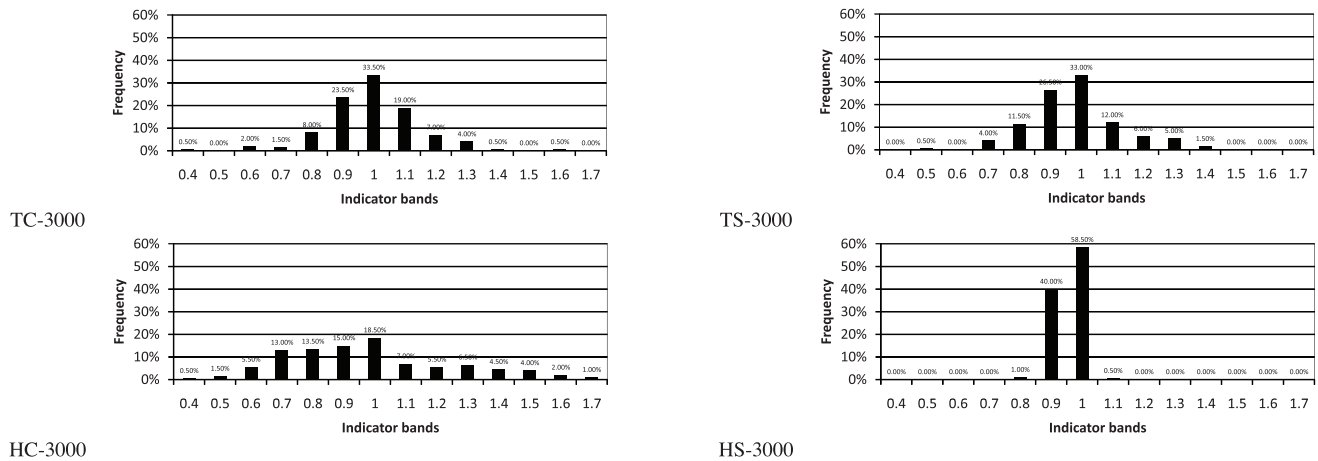

Fig. 6 Ratio distribution of (the travel time by a randomly replaced plan)/(the travel time by a normally decided plan). The graphs are shown along indicator bands on the X axis with the percentage on the Y axis. Each indicator band on the X axis means corresponding the range of ratio, e.g., the indicator “0.9” means the range between [0.9, 1.0].

Table 3 The travel time of the normally decided plan and the random one. These plans are of the same user and the other users’ plans are not changed. The upper and the lower values in each cell are the average travel time and the standard deviation.

	Normal Plan	Random Plan	Ratio (Ran./Nor.)
TC-3000	13,589.7 (3,847.9)	14,088.1 (4,037.5)	104.70%
TS-3000	12,758.9 (4,516.0)	12,978.4 (4,625.0)	103.27%
HC-3000	5,584.2 (1,787.7)	5,680.5 (1,927.8)	104.80%
HS-3000	5,091.8 (1,424.6)	5,099.4 (1,444.1)	100.06%

these results can empirically show the optimality of the cost estimate. In this experiment, if we find the improvement of the travel time by the replacement of the selected alternative to a random one, it means that some users did not select the best choice. On the other hand, if we do not find the improvement by a random replacement, it means that almost all users could probably find the best choice in their plan.

The graphs in Fig. 6 show the ratio distribution of the travel time of a replaced random plan and a normal one in each case. In these graphs, a band indicator less than 1.0 corresponds to the case that the travel time of the random plan outperforms that of the normally decided one, and a band more than 1.0 indicates that the normally decided plan is better than the random one. Table 3 shows the averaged travel time and the ratio in those two plans, which are calculated from the same simulation results.

In the results of the theme park scenario, we can see that there are many better plans than the normally decided one in both cases of TC-3000 and TS-3000. The percentage of better plans in TC-3000 is about 36%, and about 43% in TS-3000. This is not good news but the reason is simple. In the theme park scenario, the former users and the latter users share the facilities in the same network. The former users optimize their plans before the latter users appear, and their plans interfere each other in the later part of the former user plans. The estimated cost by the former users is changed by the latter users, and the former users consequently fail to optimize their plans.

In the results of the highway scenario, in the case of HC-3000, the 49% percentage of random plans shows a better performance than the normally decided one. In the case of HS-3000, the random plans show almost the same performance as the normal one. The users in the highway scenario flow one-way from an origination side to a destination side in the network, and the former users are temporally and spatially separated from the later users. Thus, the planning with the SCE works very well. The fact that the random plans and the normal plan show the same performance in HS-3000 means that the users cannot find another better plan than the current one and the whole behavior achieves near a user-equilibrium situation. It is the Nash-equilibrium situation of traffic systems and it is important that the users with the SCE achieve such a situation without preliminary knowledge, perfect rationality or learnability in a repeatable situation.

5. Discussion

The experimental results show that the SCE has a better performance than the CCE. The SCE is a kind of advance queue simulation and indirect negotiations among the users. Although a simultaneous participation of whole users takes good effect in principle, the SCE is spoiled in its performance by the situation that the latter user behavior interferes the later part of the former user plan. It is particularly conspicuous in the theme park scenario. To improve the performance of the SCE, a supplementary term which counts up potential users is necessary to add to Eq. (5). Such a supplementary term does not have to include the details of individual user plans, and a kind of stochastic prediction could be applied.

In the experiments, we have picked up only the CCE as a contrast. Although we could build other planning with ad-hoc heuristics and it may be better than the proposal, we are not concerned with such a heuristic method. The heuristic method for this type of problem would utilize explicit or implicit features of a problem setting, and the change of setting, e.g., topology of a network, easily affects the performance of the method. It could not be a fundamental solution of the problem.

In addition, the experimental results with some density patterns

of users showed that the performance difference between the SCE and the CCE is not simple. In the theme park scenario, the SCE consistently exhibited a better performance than the CCE, and the performance difference became linearly larger according to the density of users. In the highway scenario, although the SCE exhibited a better performance than the CCE, the advantage of the SCE seems unstable and not linear. It indicates that the effectiveness of coordination between the users is not simple and the relationship between the congestion behavior of the system and the coordination should be carefully investigated.

If this user-in-the-loop forecasting is applied to a real application, e.g., car navigation systems, we have to carefully investigate the diffusion process of the system in advance. The system must give the users sufficient incentive to follow a plan during a transitional period of diffusion. Otherwise, nobody could use the system even if everybody knows it contributes to improve the total performance of the facility allocation. The supplementary term of the users who do not use the proposed system could be necessary.

Our first aim of this research is to lead users' behavior to a Nash-equilibrium or user-equilibrium by sophisticated information technology. Of course we know that game theory clarifies such an equilibrium does not always become the best result in any situation, but the total time slot of a facility is fixed and individual efficient use of facilities could lead to improve the total system performance. The complexity in more realistic problems makes a system difficult to be analyzed in a game theoretical fashion but we can know a part of the full picture by an empirical analysis and it is important to tackle such complicated problems [19].

Further our interest is, if it exists, to bridge the gap between the Nash-equilibrium and the Pareto optimum in facility allocation problems. In this paper we modeled the situation that the users can utilize all facilities and the cost of users is the summation of a waiting time. However, many actual facilities, e.g., highways, require not only time but money cost which is one of outside parameters of the system. We cannot easily control the time cost under the facility capacity constraint but it is possible to tackle the money cost control, actually such a control is studied in road pricing researches. If we can control the money cost of each facility in real time by the statements of users, it could change the game structure and contribute to bridge the gap between the Nash-equilibrium and the Pareto optimum in the system. A market-oriented way related with the statements, time cost and money cost would be available for such a control [18].

Our proposal is effective to improve the global load of systems, and it would be more effective to combine more local excellent contrivance. For example, Dresner proposes the reservation system in which car drivers adjust entering timing to an intersection with each other and they can pass through the intersection without stop signals [4]. The idea, like seamless connection of our proposal and such systems, is effective to drastically reduce traffic jams.

In the experiment, we do not confirm the optimality of social welfare with the proposed method. To investigate the optimality of social welfare, we have to find the optimum solution to maximize the social welfare, however, the solution space of this problem is very huge and finding the optimum solution is difficult.

For example in TC-3000 and TS-3000 with 3000 user agents, each user has 24 possible visiting patterns and the whole solution space of these settings is 24^{3000} . In HC-3000 and HS cases, each user has 11 alternatives on average from the origination to the destination, and the total solution space is 11^{3000} . In addition, the social optimum may force some users to receive individually a worse plan unfairly and it cannot be acceptable for all users. According to the above reason, it is not easy to discuss about the head room to optimal solutions.

6. Conclusions

In this paper, we proposed the user-in-the-loop forecasting with the statement-based cost estimate, and applied to two types of facility allocation models, i.e., the theme park scenario and the highway scenario. The computer experiments showed that the proposed estimate caused a better result in both scenarios than the current cost estimate. In the highway scenario, the users with the statement-based cost could achieve a user-equilibrium without any preliminary knowledge, perfect rationality or learnability. However, the users in the theme park scenario could not select the best response because the latter users unexpectedly affected the later part of the former user's plan. As a next step, we will focus on the supplementation of potential or not-participating users effect, modeling of time and money cost, and introducing of market mechanisms.

Acknowledgments We are grateful to Koichi Kurumatani from the National Institute of Advanced Industrial Science and Technology, Japan, for his valuable comments on the simulation model. We also very thankful to Prof. Azuma Ohuchi from Hokkai School of Commerce, Japan, for his comments on this research. This work was supported by JSPS KAKENHI Grant Number 21680014.

References

- [1] Arnott, R., de Palma, A. and Lindsey, R.: Does providing information to drivers reduce traffic congestion?, *Transportation Research*, Vol.25A, No.5, pp.309–318 (1991).
- [2] Arthur, W.B.: Inductive reasoning and bounded rationality (the el farol problem), *American Economic Review*, Vol.84, pp.406–411 (1994).
- [3] Dijkstra, E.W.: A note on two problems in connexion with graphs, *In Numerische Mathematik*, Vol.1, pp.269–271 (1959).
- [4] Dresner, K. and Stone, P.: Multiagent traffic management. A reservation-based intersection control mechanism, *Proc. 3rd International Joint Conference on Autonomous Agents and Multiagent Systems*, pp.530–537 (2004).
- [5] Fischer, S. and Vücking, B.: Adaptive routing with stale information, *Proc. 24th Annual ACM Symposium on Principles of Distributed Computing*, pp.276–283 (2005).
- [6] Kawamura, H., Kataoka, T., Kurumatani, K. and Ohuchi, A.: Investigation of global performance affected by congestion avoiding behavior in theme park problem, *IEEJ Trans. Electronics, Information and Systems*, Vol.10, No.124, pp.1922–1929 (2004).
- [7] Kawamura, H., Kurumatani, K. and Ohuchi, A.: Modeling of theme park problem with multiagent for mass user support, *Lecture Notes in Artificial Intelligence 3012, Multi-agent for Mass User Support*, pp.48–69 (2004).
- [8] Klügl, F. and Bazzan, A.L.C.: Simulation studies on adaptive route decision and the influence of information on commuter scenarios, *Intelligent Transportation Systems*, Vol.8, pp.223–232 (2004).
- [9] Klügl, F., Bazzan, A.L.C. and Wahle, J.: Selection of information types based on personal utility, a testbed for traffic information markets, *Proc. 2nd International Joint Conference on Autonomous Agents and Multiagent Systems*, pp.377–384 (2003).
- [10] Kurumatani, K.: Mass user support by social coordination among cit-

- izens in a real environment, *Lecture Notes in Artificial Intelligence 3012, Multi-agent for Mass User Support*, pp.1–17 (2004).
- [11] Mahmassani, H.S. and Jayakrishnan, R.: System performance and user response under real-time information in a congested traffic corridor, *Transportation Research A*, Vol.25, No.5, pp.293–307 (1991).
 - [12] Muguda, N., Wurman, P.R. and Young, R.M.: Experiments with planning and markets in multiagent systems, *SIGecom Exchanges*, Vol.5, No.1, pp.34–47 (2004).
 - [13] Prado, J.E. and Wurman, P.R.: Non-cooperative planning in multi-agent resource-constrained environments with markets for reservations, *AAAI 2002 Workshop on Planning with and for Multiagent Systems*, pp.60–66 (2002).
 - [14] Shiose, T., Onitsuka, T. and Taura, T.: Effective information provision for believing traffic congestion, *Proc. 4th International Conference on Intelligence and Multimedia Applications*, pp.138–142 (2001).
 - [15] Suzuki, R. and Arita, T.: Effects of information sharing on collective behaviors in competitive populations, *Proc. 8th International Symposium on Artificial Life and Robotics*, pp.36–39 (2003).
 - [16] Wahle, J., Bazzan, A.L.C., Klügl, F. and Schreckenberg, M.: Decision dynamics in a traffic scenario, *Physica A*, Vol.287, No.3–4, pp.669–681 (2000).
 - [17] Wardrop, J.G.: Some theoretical aspects of road traffic research, *Proc. Institute of Civil Engineers*, Vol.2, pp.325–378 (1952).
 - [18] Wellman, M.P.: A market-oriented programming environment and its application to distributed multicommodity flow problems, *Artificial Intelligence Research*, Vol.1, pp.1–22 (1993).
 - [19] Wellman, M.P.: Methods for empirical game-theoretic analysis, *Proc. 21st National Conference on Artificial Intelligence*, pp.1152–1155 (2006).
 - [20] Yamashita, T., Izumi, K., Kurumatani, K. and Nakashima, H.: Smooth traffic flow with a cooperative car navigation system, *Proc. 4th International Joint Conference on Autonomous Agents and Multiagent Systems*, pp.478–485 (2005).
 - [21] Yoshii, T., Akahane, H. and Kuwahara, M.: An evaluation on effects of dynamic route guidance on an urban expressway network, *Proc. 2nd World Congress on Intelligent Transport Systems*, Vol.4, pp.1995–2000 (1995).
 - [22] Yoshii, T., Akahane, H. and Kuwahara, M.: Impacts of the accuracy of traffic information in dynamic route guidance systems, *Proc. 3rd World Congress on Intelligent Transport Systems (CD-ROM)* (1996).



Keiji Suzuki received his Ph.D. from Hokkaido University in 1993. He became an instructor and an associate professor at Hokkaido University in 1993 and 1996, respectively. He became an associate professor and a professor at Future University Hakodate in 2000 and 2004, respectively. He became a professor at Hokkaido Uni-

versity in 2008. His current research interest is multi-agent systems. He is a member of Japanese Society for Artificial Intelligence (JSAI), IPSJ, Society of Tourism Informatics Japan (STI), and The Robotics Society of Japan (RSJ).

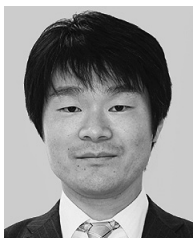

Hidenori Kawamura received his Ph.D. from Hokkaido University in 2000. He became an instructor and an associate professor at Hokkaido University in 2000 and 2006, respectively. His current research interest is multi-agent systems. He is a member of Japanese Society for Artificial Intelligence (JSAI), IPSJ, Society of

Tourism Informatics Japan (STI), and the Robotics Society of Japan (RSJ).

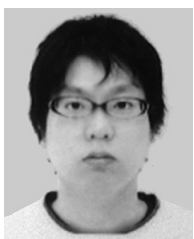

Ryota Ono received his M.E. from Hokkaido University in 2012. He is studying service science and recommender systems at the Doctoral Program in Hokkaido University. He is a member of Japanese Society for Artificial Intelligence (JSAI), and Society of Tourism Informatics Japan (STI).