

# A Fuzzy Admission Call Control Scheme for Multimedia Applications

Leonard Barolli<sup>‡</sup>, Takahide Gouda<sup>†</sup>, Makoto Ikeda<sup>‡</sup>,  
Kaoru Sugita<sup>‡</sup>, Akio Koyama<sup>††</sup>

<sup>‡</sup>Department of Information and Communication Engineering  
Fukuoka Institute of Technology (FIT)  
3-30-1 Wajiro-Higashi, Higashi-ku, Fukuoka 811-0295, Japan  
E-mail: {barolli, sugita}@fit.ac.jp

<sup>†</sup> Graduate School of Engineering, Fukuoka Institute of Technology (FIT)  
3-30-1 Wajiro-Higashi, Higashi-ku, Fukuoka 811-0295  
E-mail: mgm04004@ws.ipc.fit.ac.jp

<sup>††</sup>Department of Informatics, Yamagata University  
4-3-16 Jonan, Yonezawa 992-8510, Yamagata  
E-mail: akoyama@eie.yz.yamagata-u.ac.jp

## Abstract

The purpose of admission control is to support the Quality of Service (QoS) demands of real time applications via resource reservation. In order to deal with admission control for high-speed networks, in a previous work we proposed a fuzzy based admission control scheme which is flexible and adaptive and makes an intelligent decision for call acceptance. In the previous work, we considered only two indicators for QoS and congestion control. However, for multimedia applications more QoS and CC parameters should be considered. In this paper, we extend our previous work by proposing two additional schemes which are integrated in the previous scheme. The new scheme is called Fuzzy Admission Control for Multimedia applications (MFAC). In this paper, we introduce the conventional admission control schemes and give some simulation results of their performance. We explain the proposed MFAC scheme and present the design of Fuzzy QoS Controller (FQC) and Fuzzy Congestion Controller (FCC).

## 1 Introduction

Ensuring the Quality of Service (QoS) demands to traffic flows and groups of flows is an important challenge for future broadband networks, and resource provisioning via admission control is a key mechanism for achieving this [1, 2]. The Call Admission Control (CAC) deals with acceptance or rejection of new connections. The decision is done based on how the new connection affects the Quality of Service (QoS) of the existing connections and network resources. After a call is accepted by CAC procedure, the call may exceed the parameters declared in call-setup phase. Therefore, a Policing Mechanisms (PM) is needed to act on each source before all the traffic is multiplexed, in order to guarantee the negotiated QoS.

Traditional CAC schemes can be classified in equivalent capacity, heavy traffic approximation, upper bounds of the cell loss probability, fast buffer/bandwidth allocation, and time windows. Among proposed CAC schemes, the equivalent capacity gives better results [3]. But, the equivalent capacity scheme makes many approximations, which result in an overestimate of equivalent capacity. Using conventional CAC scheme, it is not easy to accurately determine the effective bounds or equivalent capacity in various bursty traffic flow conditions of high-speed networks. Thus, to cope with rapidly changing network conditions and bursty traffic, the traffic control methods for high-speed networks must be adaptive, flexible, and intelligent for efficient network management.

Use of intelligent methods based on Fuzzy Logic (FL), Neural Networks (NN) and Genetic Algorithms (GA) can

prove to be efficient for traffic control in high speed networks [4, 5, 6]. In Ref.[4], the FL is used to build a fuzzy PM, which performance is better than conventional PMs and very close to ideal behavior. Some NN applications for traffic control in high-speed networks are proposed in Ref.[5]. The NN are well suited to applications in the control of communications networks due to their adaptability and high speed. They can achieve an efficient adaptive control through the use of adaptive learning capabilities. A GA based routing method is proposed in Ref.[6]. The proposed routing algorithm has a fast decision and shows an adaptive behavior based on GA.

In our previous works [7, 8], we proposed a Fuzzy Admission Control (FAC) scheme and a Fuzzy Equivalent Capacity Estimator (FECE). In the FAC scheme, we considered only two indicators for QoS and congestion control. However, for multimedia applications more QoS and CC parameters should be considered. In this paper, we extend our previous work by proposing two additional schemes which are integrated in the previous scheme. The new scheme is called Fuzzy Admission Control for Multimedia applications (MFAC). In this paper, we introduce the conventional admission control schemes and give some simulation results of their performance. We explain the proposed MFAC scheme and present the design of Fuzzy QoS Controller (FQC) and Fuzzy Congestion Controller (FCC). The performance of the new scheme and the comparison with conventional ones is for the future work.

The organization of this paper is as follows. In the next Section, we will introduce conventional CAC schemes. In

Section 3, we present our previous work. In section 4, we propose the new MFAC. In Section 5, we give some simulation results. Finally, conclusions are given in Section 6.

## 2 Conventional CAC Schemes

The CAC deals with the question of whether or not a node can accept a new connection. The decision to accept or reject a new connection is based on the following questions: does the new connection affect the QoS of the connections currently being carried by the network? can the network provide the QoS requested by the new connection?

A variety of different CAC schemes have been proposed. They are classified into the following groups: equivalent capacity; heavy traffic approximation; upper bounds of the cell loss probability; fast buffer/bandwidth allocation; and time windows [3].

The equivalent capacity is a popular scheme for CAC. The equivalent capacity is computed from the combination of two different approaches, one based on a fluid flow model and the other one on an approximation of the stationary bit rate distribution [9]. These two approaches are used because they complement each other, capturing different aspects of the behavior of multiplexing connections.

Sohraby [10] proposed an approximation for bandwidth allocation based on the asymptotic behavior of the tail of the queue length distribution. Saito [11] proposed a CAC scheme by inferring the upper bound of cell loss probability from the traffic parameters specified by user.

The fast buffer/bandwidth allocation scheme was devised for the transmission of bursty sources. In this scheme, when a virtual circuit is established, the path through the network is set up and the routing tables are appropriately updated, but no resources are allocated to the virtual circuit. When a source is ready to transmit a burst, at that moment the network attempts to allocate necessary resources for the burst duration [12].

In time window scheme, a source is only allowed to transmit up to a maximum number of bits within a fixed period of time which is known as time window. Golestani [13] proposed a mechanism where for each connection the number of cells transmitted on any link in the network is bounded. Thus, a smooth traffic flow is maintained throughout the network. This is achieved using the notion of a frame which is equal to a fixed period of time. For each connection, the number of cells per frame transmitted on an outgoing link cannot exceed its upper bound.

The above mentioned CAC schemes suffer from some fundamental limitations. Generally, it is difficult for a network to acquire complete statistics of input traffic. As a result, it is not easy to accurately determine the effective bounds or equivalent capacity in a various bursty traffic flow conditions of high-speed networks. Among proposed CAC schemes, the equivalent capacity gives better results [3]. However, as both fluid flow and stationary approximations overestimate the actual value of the equivalent capacity and are inaccurate for different ranges of connections characteristics, the equivalent capacity method also overestimates the actual bandwidth requirements.

## 3 Our Previous Work

In order to make a more accurate decision for connection acceptance, we proposed a fuzzy based CAC scheme, called FAC scheme [7]. The Fuzzy Logic Controller (FLC) is the main part of the FAC and its basic elements are shown in Fig.1. They are the fuzzifier, inference engine, Fuzzy Rule Base (FRB) and defuzzifier. As membership functions, we use triangular and trapezoidal membership functions because they are suitable for real-time operation [14]. They are shown in Fig.2.

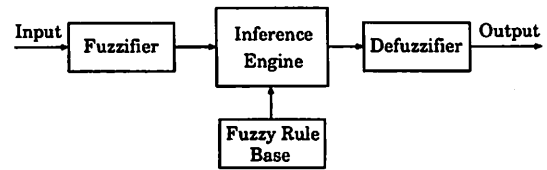

Figure 1: FLC structure.

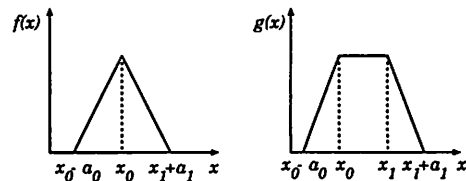

Figure 2: Triangular and trapezoidal membership functions.

In difference from the equivalent capacity admission control method [9], which uses only the available capacity as the only variable for CAC, the FAC scheme considers four parameters: Quality of service ( $Qs$ ), Network congestion parameter ( $Nc$ ), Available capacity ( $Ac$ ), and user requirement parameter which is expressed by Equivalent capacity ( $Ec$ ) [7]. We decided the number of membership functions for each linguistic parameters based on many simulations. We found that two membership functions are enough for  $Qs$ ,  $Nc$ ,  $Ac$  linguistic parameters, and three membership functions are enough for  $Ec$  linguistic parameter. The output linguistic parameter is the Acceptance decision ( $Ad$ ). In order to have a soft admission decision, not only “accept” and “reject” but also “weak accept”, “weak reject”, and “not accept not reject” are used to describe the accept/reject decision. The membership functions for input and output linguistic parameters are shown in Fig.3. The small letters  $e$ ,  $c$ ,  $w0$  and  $w1$  mean edge, center, right width and left width, respectively. In the case of trapezoidal membership functions which have only one width, we write the width simply as  $w$ . While, in the case of triangular functions, the widths are written as  $w0$  and  $w1$ .

The term sets of  $Qs$ ,  $Nc$ ,  $Ac$ , and  $Ec$  are defined respectively as:

$$\begin{aligned}
 T(Qs) &= \{Satisfied, NotSatisfied\} = \{S, NS\}; \\
 T(Nc) &= \{Negative, Positive\} = \{N, P\}; \\
 T(Ac) &= \{NotEnough, Enough\} = \{NE, E\}; \\
 T(Ec) &= \{small, medium, big\} = \{sm, me, bi\}.
 \end{aligned}$$

The membership functions for input parameters of FAC are defined as follows:

$$\begin{aligned}
 \mu_S(Qs) &= g(\log(Qs); 0, S_e, 0, S_w); \\
 \mu_{NS}(Qs) &= g(\log(Qs); N_{s_e}, 1, N_{s_w}, 0); \\
 \mu_N(Nc) &= g(Nc; -1, N_e, 0, N_w); \\
 \mu_P(Nc) &= g(Nc; P_e, 1, P_w, 0); \\
 \mu_{NE}(Ac) &= g(\log(Ac); 0, NE_e, 0, NE_w); \\
 \mu_E(Ac) &= g(\log(Ac); E_e, 1, E_w, 0); \\
 \mu_{sm}(Ec) &= g(\log(Ec); Abr, sm_e, 0, sm_w); \\
 \mu_{me}(Ec) &= f(\log(Ec); me_e, me_w0, me_w1); \\
 \mu_{bi}(Ec) &= g(\log(Ec); bi_e, Pr, bi_w, 0).
 \end{aligned}$$

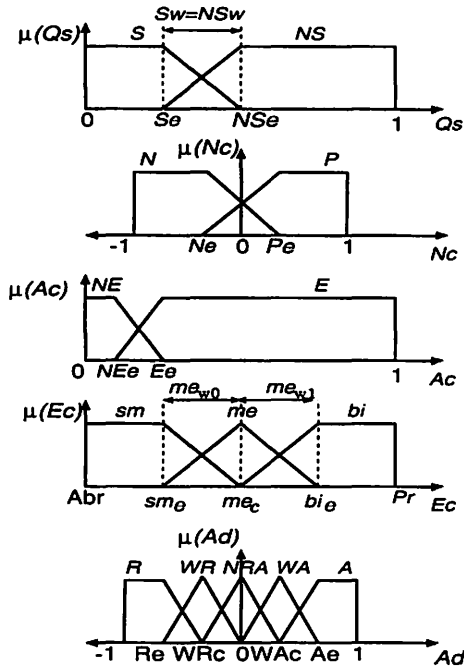

Figure 3: FAC membership functions.

The term set of the output linguistic parameter  $T(Ad)$  is defined as {Reject, Weak Reject, Not Reject Not Accept, Weak Accept, Accept}. We write for short as {R, WR, NRA, WA, A}. The membership functions for the output parameter  $Ad$  are defined as follows:

$$\begin{aligned} \mu_R(Ad) &= g(Ad; -1, R_e, 0, R_w); \\ \mu_{WR}(Ad) &= f(Ad; WR_c, WR_{w0}, WR_{w1}); \\ \mu_{NRA}(Ad) &= f(Ad; NRA_c, NRA_{w0}, NRA_{w1}); \\ \mu_{WA}(Ad) &= f(Ad; WA_c, WA_{w0}, WA_{w1}); \\ \mu_A(Ad) &= g(Ad; A_e, 1, A_w, 0). \end{aligned}$$

The FRB forms a fuzzy set of dimensions  $|T(Q_s)| \times |T(N_c)| \times |T(A_c)| \times |T(E_c)|$ , where  $|T(x)|$  is the number of terms on  $T(x)$ . The FRB of FAC is shown in Table 1 and has 24 rules. The control rules have the following form: IF "conditions" THEN "control action". Statements on conditions go like "the  $Q_s$  is satisfied" or "the  $N_c$  is congested". Likewise, statements on control action might be "reject" or "accept".

In order to have a simple FRB and a good admission decision we selected 4 input linguistic parameters and one output linguistic parameter. To have a soft admission decision, not only  $A$  and  $R$ , but also  $WA$ ,  $NRA$ , and  $WR$  are used as output membership functions. Because there are 4 input linguistic parameters, the maximal and minimal number of the membership functions fired at a moment of time is 8 and 4, respectively. To decide an appropriate output membership function, the strength of each rule must be considered. For this reason, the output membership function is a complicated function and we use as a defuzzification method the center of area method, which get the center point of the fuzzy output membership function. This value is used for admission control. As a result, the connections will be accepted if the output value is more than zero and will be rejected if the output value will be less than zero.

Table 1: FRB of FAC.

Rule	$Q_s$	$N_c$	$A_c$	$E_c$	$Ad$
0	S	N	NE	sm	NRA
1	S	N	NE	me	WR
2	S	N	NE	bi	WR
3	S	N	E	sm	WA
4	S	N	E	me	NRA
5	S	N	E	bi	WR
6	S	P	NE	sm	WA
7	S	P	NE	me	NRA
8	S	P	NE	bi	WR
9	S	P	E	sm	A
10	S	P	E	me	A
11	S	P	E	bi	A
12	NS	N	NE	sm	R
13	NS	N	NE	me	R
14	NS	N	NE	bi	R
15	NS	N	E	sm	NRA
16	NS	N	E	me	NRA
17	NS	N	E	bi	R
18	NS	P	NE	sm	WR
19	NS	P	NE	me	R
20	NS	P	NE	bi	R
21	NS	P	E	sm	NRA
22	NS	P	E	me	NRA
23	NS	P	E	bi	WR

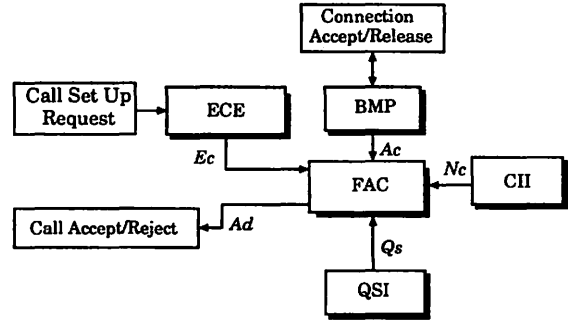

Figure 4: FAC scheme.

The FAC scheme is shown in Fig.4. The information for FAC are given by Bandwidth Management Predictor (BMP); Congestion Information Indicator (CII); QoS Indicator (QSI); and Equivalent Capacity Estimator (ECE). The BMP works in this way: if a connection is accepted, the connection bandwidth is subtracted from the available capacity of the network, otherwise, if a connection is released, the connection bandwidth is added to the available capacity of the network. The CII decides whether the network is or isn't congested. The QSI determines whether allowing a new connection violates or not the QoS guarantee of the existing connections.

In order to get a better estimation of  $E_c$ , we introduced a Fuzzy ECE (FECE) scheme [8]. The FECE predicts the  $E_c$  required for a new connection based on the traffic parameters Peak rate ( $Pr$ ), Source utilization ( $Su$ ), and Peak bit-rate duration ( $Pbd$ ). The membership functions for FECE are shown in Fig.5. The term sets of  $Pr$ ,  $Su$ , and  $Pbd$  are defined respectively as:

$$\begin{aligned} T(Pr) &= \{Small, Medium, Large\} = \{S, M, L\}; \\ T(Su) &= \{Low, High\} = \{Lo, Hi\}; \\ T(Pbd) &= \{Short, Medium, Long\} = \{Sh, Me, Lg\}. \end{aligned}$$

Based on many simulations, we decided that three

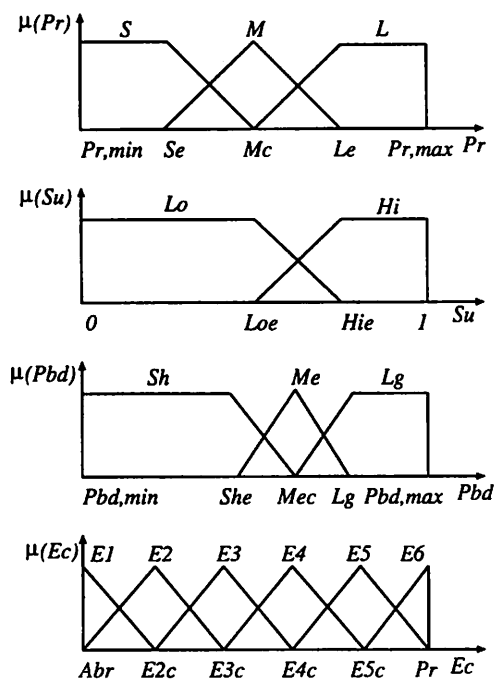

Figure 5: FECE membership functions.

membership functions are enough for  $Pr$  linguistic parameter, two membership functions are enough for  $Su$  linguistic parameter, and three membership functions are enough for  $Pbd$  linguistic parameter.

The set of the membership functions associated with terms in the term set of  $Pr$ ,  $T(Pr) = \{S, M, L\}$ , are denoted by  $M(Pr) = \{\mu_S, \mu_M, \mu_L\}$ , where  $\mu_S, \mu_M, \mu_L$  are the membership functions for  $S, M, L$ , respectively. They are given by:

$$\begin{aligned}\mu_S(Pr) &= g(\log(Pr); Pr, min, S_e, 0, S_w); \\ \mu_M(Pr) &= f(\log(Pr); M_c, M_{w0}, M_{w1}); \\ \mu_L(Pr) &= g(\log(Pr); L_e, Pr, max, L_w, 0).\end{aligned}$$

$M(Su) = \{\mu_{Lo}, \mu_{Hi}\}$  are the membership functions for term set of  $Su$ . The membership functions  $\mu_{Lo}, \mu_{Hi}$  are given by:

$$\begin{aligned}\mu_{Lo}(Su) &= g(Su; 0, Loe, 0, Low); \\ \mu_{Hi}(Su) &= g(Su; Hie, 1, Hiw, 0).\end{aligned}$$

The membership functions for term set  $Pbd$  are  $M(Pbd) = \{\mu_{Sh}, \mu_{Me}, \mu_{Lg}\}$ , and  $\mu_{Sh}, \mu_{Me}, \mu_{Lg}$  are given by:

$$\begin{aligned}\mu_{Sh}(Pbd) &= g(\log(Pbd); Pbd, min, She, 0, Shw); \\ \mu_{Me}(Pbd) &= f(\log(Pbd); Mec, Me_{w0}, Me_{w1}); \\ \mu_{Lg}(Pbd) &= g(\log(Pbd); Lge, Pbd, max, Lgw, 0).\end{aligned}$$

The  $Ec$  for a connection should fall between its  $Pr$  and Average bit rate ( $Abr$ ). Based on the number of input membership functions, we divide the  $Ec$  range in six membership functions. The term of  $Ec$  is defined as  $T(Ec) = \{E1, E2, E3, E4, E5, E6\}$ .

The term set of the output membership functions, are denoted by  $M(Ec)$ . They are written as

Table 2: FRB of FECE.

Rule	Pr	Su	Pbd	Ec
0	S	Lo	Sh	E1
1	S	Lo	Me	E2
2	S	Lo	Lg	E5
3	S	Hi	Sh	E1
4	S	Hi	Me	E1
5	S	Hi	Lg	E4
6	M	Lo	Sh	E1
7	M	Lo	Me	E3
8	M	Lo	Lg	E6
9	M	Hi	Sh	E1
10	M	Hi	Me	E2
11	M	Hi	Lg	E5
12	L	Lo	Sh	E4
13	L	Lo	Me	E6
14	L	Lo	Lg	E6
15	L	Hi	Sh	E3
16	L	Hi	Me	E5
17	L	Hi	Lg	E6

$\{\mu_{E1}, \mu_{E2}, \mu_{E3}, \mu_{E4}, \mu_{E5}, \mu_{E6}\}$ , and are given by:

$$\begin{aligned}\mu_{E1}(Ec) &= f(\log(Ec); E1_c, 0, E1_{w1}); \\ \mu_{E2}(Ec) &= f(\log(Ec); E2_c, E2_{w0}, E2_{w1}); \\ \mu_{E3}(Ec) &= f(\log(Ec); E3_c, E3_{w0}, E3_{w1}); \\ \mu_{E4}(Ec) &= f(\log(Ec); E4_c, E4_{w0}, E4_{w1}); \\ \mu_{E5}(Ec) &= f(\log(Ec); E5_c, E5_{w0}, E5_{w1}); \\ \mu_{E6}(Ec) &= f(\log(Ec); E6_c, E6_{w0}, 0).\end{aligned}$$

The FRB of FECE is shown in Table 2 and has 18 rules. Because there are three input linguistic parameters the maximal and minimal number of the membership functions fired at a moment of time is 6 and 3, respectively. To decide an appropriate output membership function, the strength of each rule must be considered. Also, a trade-off between the evaluation accuracy and the FRB complexity is needed. For this reason, we selected three input linguistic parameters and the parameter values of output membership functions are assigned as follows. The value of  $E1_c$  is set equal to  $Abr$  and the value of  $E6_c$  is set equal to  $Pr$ . The other values are calculated based on the following equation:

$$Ei_c = E(i-1)_c + (Pr - Abr)/5 \quad (1)$$

where  $i = 2, 3, 4, 5, 6$ .

## 4 Proposed MFAC Scheme

In our previous work, we considered only two indicators for QoS and CC. However, for multimedia applications more QoS and CC parameters should be considered. For this reason, in this paper we design two fuzzy based controllers: FQC and FCC. The scheme of proposed FCAC is shown in Fig.6.

### 4.1 FQC

As input linguistic parameters for FQC, we consider the throughput  $Th$ , the delay  $D$ , and the loss probability  $Lp$ . The membership functions for FQC are shown in Fig.7. The term sets of  $Th, D$ , and  $Lp$  are defined respectively as:

$$\begin{aligned}T(Th) &= \{Small, Medium, Large\} = \{Sa, Mu, Lr\}; \\ T(D) &= \{Low, Middle, High\} = \{Lo, Mi, Hi\}; \\ T(Lp) &= \{Low, Normal, High\} = \{Lw, Nr, Hg\}.\end{aligned}$$

From our experience, we decided that three membership functions are enough for  $Th$  linguistic parameter, three

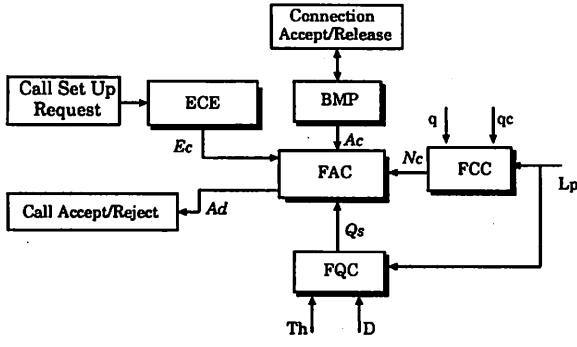

Figure 6: Proposed MFAC scheme.

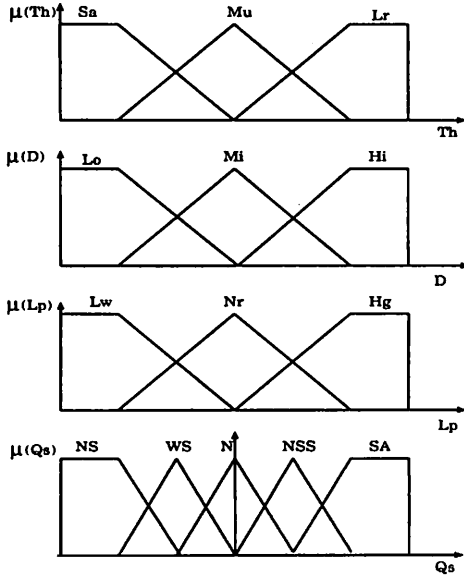

Figure 7: FQC membership functions.

membership functions are enough for  $D$  linguistic parameter, and two membership functions are enough for  $Lp$  linguistic parameter.

The term set of the output linguistic parameter  $T(Qs)$  is defined as {Not Satisfied, Weak Satisfied, Normal, Not So Satisfied, Satisfied}. We write for short as {NS, WS, N, NSS, SA}.

#### 4.2 FCC

For FCC, as input linguistic parameters, we consider the queue length  $Ql$ , the queue length change rate  $Qcr$ , and the loss probability  $Lp$ . The membership functions for FCC are shown in Fig.8. The term sets of  $Ql$ ,  $Qcr$ , and  $Lp$  are defined respectively as:

$$\begin{aligned} T(Ql) &= \{Empty, Middle, Full\} = \{E, Mi, Fu\}; \\ T(Qcr) &= \{Negative, Positive\} = \{Ne, Po\}; \\ T(Lp) &= \{Low, Normal, High\} = \{Lw, Nr, Hg\}. \end{aligned}$$

Usually for congestion control is used a two threshold congestion method. In this method the system is considered congested if the queue length exceeds the high threshold and uncongested if the queue length drops below the low threshold. For this reason, the maximum value of  $Ql$  would be the total buffer size. The edges of the membership functions can be the low and high threshold. For the

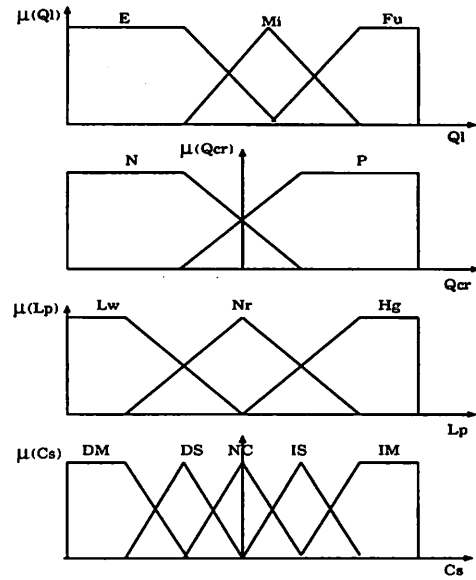

Figure 8: FCC membership functions.

$Qcr$  linguistic parameter the maximum positive and negative queue length change would be the queue length. For the  $Lp$  linguistic parameter, the values for "Low", "Normal" and "High" can be decided considering the required  $QoS$ .

The term set of the output linguistic parameter  $T(Cs)$  is defined as {Decrease More, Decrease Slightly, No Congestion, Increase Slightly, Increase More}. We write for short as {DM, DS, NC, IS, IM}.

## 5 Simulation Results

The FAC and MFAC schemes use the same mechanism (FECE) for estimation of equivalent capacity. The new MFAC has the same properties as FAC but also has a better estimation of  $QoS$  and CC indicators. In following, we compare by simulations the performance of FECE with conventional methods such as fluid flow approximation and stationary approximation. The performance comparison between Guérin's method and our proposed approximation for  $N = 50$  is shown in Fig.9. At the beginning, both methods have the same behavior, because they use the stationary approximation. But, as the source utilization increases, our method makes a better estimation than Guérin's method. For  $Su = 0.5$ , our method and the exact value are very close. Otherwise, Guérin's method has a difference of about one order of magnitude compared with the exact value. For high source utilization, Guérin's method uses the flow approximation and the characteristic is approaching the exact value. However, our method shows a better performance even for high source utilization.

In order to compare the statistical multiplexing gain of FAC scheme and equivalent capacity method, we consider a multiplexer which can process two classes of connections: class 1 and class 2. We consider that all connections in a class have the same traffic parameters  $Pr = 4$  Mb/s,  $Su = 0.4$ ,  $Pbd = 0.106$  s, and  $Pr = 10$  Mb/s,  $Su = 0.4$ ,  $Pbd = 0.021$  s, for class 1 and class 2, respectively.

Using the FAC scheme and equivalent capacity method, the admission regions for the buffer size 1 000 cells are shown in Fig.10. As the buffer size increases, the number of connections admitted into the network is increased. The FAC scheme can admit more connections than equivalent capacity method, thus increasing the network utilization.

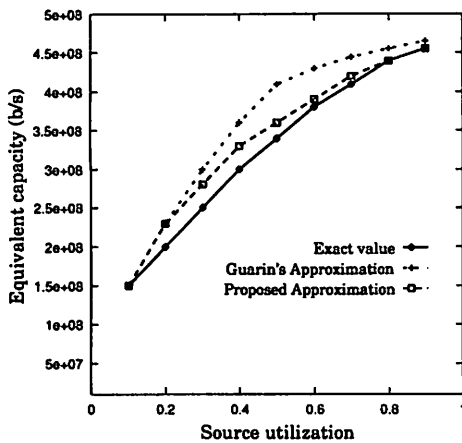

Figure 9: Performance comparison between Guérin's method and FECE.

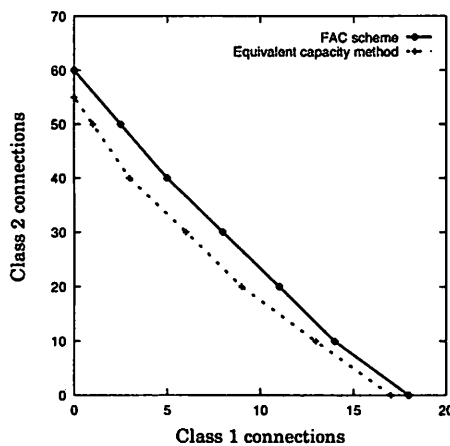

Figure 10: Admission regions.

## 6 Conclusions

In paper, we improved our previous FAC scheme by proposing and integrating together two ne fuzzy based controllers: FQC and FCC. First, we introduced the conventional CAC schemes. Next, we presented our previous FAC scheme with its components. Then, we introduced the FQC and FCC schemes and their design. We gave some simulation results and compared FAC and conventional methods.

From the simulations results, we conclude:

- the MFAC has the same features as FAC, but better decision for QSI and CII.
- our proposed approximation method has a good  $Ec$  estimation compared with conventional methods;
- combination of FECE and stationary approximation give a more accurate estimation of  $Ec$ ;
- FAC scheme has a better admission region than the equivalent capacity method.

In the future works, we will make extensive simulations to evaluate the MFAC and compare its performance with FAC and conventional methods.

## References

- [1] Barolli, L, Koyama, A, Yamada, T, Yokoyama, S, Suganuma, T and Shiratori, N.: An Intelligent Routing and CAC Framework for Large Scale Networks Based on Cooperative Agents, *Computer Communications Journal*, Vol.25, No.16, pp.1429-1442 (October 2002).
- [2] Qiu, J and Knightly E.W.: Measurement-Based Admission Control with Aggregate Traffic Envelopes, *IEEE/ACM Trans. on Networking*, Vol.9, No.2, pp.199-210 (2001).
- [3] Perros, H.G. and Elsayed, K.M.: Call Admission Control Schemes: A Review, *IEEE Commun. Magazine*, Vol.35, No.11, pp.82-91 (1996).
- [4] Barolli, L. and Tanno, K.: Policing Mechanism in ATM Networks Using Fuzzy Set Theory, *Trans. of IPSJ*, Vol.38, No.6, pp.1103-1115 (1997).
- [5] Habib, I. (Ed.): Neurocomputing in High-Speed Networks, *IEEE Commun. Magazine*, Special Issue, Vol.33, No.10 (1995).
- [6] Barolli, L., Koyama, A., Motegi, S. and Yokoyama, S.: Performance Evaluation of a Genetic Algorithm based Routing Method for High-speed Networks, *Trans. of IEE Japan*, Vol.119-C, No.5, pp.624-631 (1999).
- [7] Barolli, L, Koyama, A, Yamada, T, Yokoyama, S, Suganuma, T and Shiratori, N.: A Fuzzy Admission Control Scheme and Its Performance Evaluation, *IPSJ Journal*, Vol.42, No.12, pp.3213-3221 (2001).
- [8] Barolli, L, Koyama, A, Yamada, T, Yokoyama, S, Suganuma, T and Shiratori, N.: A Fuzzy Based Equivalent Capacity Estimation Method for Bandwidth Allocation in High-Speed Networks, *IPSJ Journal*, Vol.42, No.8, pp.2167-2175 (2001).
- [9] Guérin, R., Ahmadi, H. and Naghshineh, M.: Equivalent Capacity and Its Application to Bandwidth Allocation in High-Speed Networks, *IEEE J. Select. Areas Commun.*, Vol.9, No.7, pp.968-981 (1991).
- [10] Sohrawy, K.: On the Asymptotic Behavior of Heterogeneous Statistical Multiplexer with Applications, *Proc. of INFOCOM'92*, pp.839-347 1992.
- [11] Saito, H.: Call Admission Control in an ATM Network Using Upper Bound of Cell Loss Probability, *IEEE Trans. Commun.*, Vol.40, No.9, pp.1512-1521 (1992).
- [12] Tranchier, D.P. et al.: Fast Bandwidth Allocation in ATM Networks, *Tech. Rep. CNET-Lannion*, (1992).
- [13] Golestani, S.J.: Congestion-free Communication in Broadband Packet Networks, *IEEE Trans. Commun.*, Vol.39, pp.1802-1812 (1991).
- [14] Dubois, D., Prade, H. and Yager, R. (Eds.): *Fuzzy Sets for Intelligent Systems*, Morgan Kaufman Publishers (1993).