

Regular Paper

NEMO-based Path Aggregation System Using Mobile Routers on Multiple Vehicles

KEI TANIMOTO^{†1,*1} and SUSUMU ISHIHARA^{†2}

This paper describes the implementation and the evaluation of a link aggregation system using Network Mobility (NEMO). The link aggregation system, called NEMO SHAKE, constructs a temporal network (called an alliance) between multiple mobile routers (MRs) carried by vehicles and aggregates external links between multiple MRs and the Internet to provide a fast and reliable transmission with mobile devices in vehicles carrying MRs. We also designed a system for controlling alliances. By estimating the distance and the link condition between MRs, it can achieve a high throughput and the stability of the aggregated paths between vehicles and the Internet. We evaluated the usefulness of NEMO SHAKE and its alliance-control mechanism in real vehicular networks. We confirmed that the alliance-control mechanism can achieve a high throughput by changing the member of the alliance dynamically.

1. Introduction

Due to the recent popularity of mobile communications services (e.g., 3G mobile phones and public wireless LANs) and the miniaturization of wireless devices, people can make use of many rich network applications (e.g., VoIP, video streaming, and online gaming) outdoors or on the move. Many of today's wireless mobile devices have multiple network interfaces and we can use the one that is the most appropriate for the current situation. We have proposed a system for such communication environments that simultaneously utilizes multiple network interfaces and aggregates links between multiple mobile devices and the Internet (called external links). The system called the SHARing multiple paths procedure for a cluster network Environment (SHAKE)^{1),2)} improves the transmission speed and the reliability between mobile devices and hosts on the Internet. The system

allows a mobile device to construct a temporal network between neighboring mobile devices with short-range high-speed wireless links such as IEEE802.11a/b/g. We call such a temporal network an *alliance*. When a mobile device in an alliance communicates with a host on the Internet, it simultaneously uses both its own external links and the external links of other mobile devices in the alliance. The traffic between the mobile device and the host is distributed to multiple external links to improve the transmission speed and the reliability. Additionally, when a mobile device in the alliance is disconnected from the Internet, it can keep the connectivity to the Internet by using the external links of other mobile devices in the alliance.

Intelligent Transport Systems (ITS) are aimed at enhancing the security of road systems and the comfort of drivers. To support ITS applications (e.g., traffic information on traffic jams and accidents, and entertainment such as VoIP and video streaming), it is important to provide a high-speed and reliable connectivity between vehicles and the Internet. To this end, we designed NEMO SHAKE that implements SHAKE with Network Mobility (NEMO Basic Support, or NEMO for short³⁾). It constructs an alliance between multiple mobile routers (MRs) carried by vehicles and aggregates external links between multiple MRs and the Internet to provide a fast and reliable transmission with mobile devices in vehicles carrying MRs (mobile network nodes: MNNs). It is important to keep vehicles connected with short-range wireless links to offer a stable communication quality because the vehicles' moving speeds are different and the wireless link quality is easily affected by obstacles and channel fading. For example, if the connectivity between MRs is lost suddenly while the packet distribution mechanism of NEMO SHAKE believes that it can use multiple paths simultaneously, packets forwarded to multiple MRs will be lost. Thus, we designed a system for controlling alliances. It provides the stability of the aggregated paths between vehicles and the Internet by dynamically adding and deleting MRs from the alliance according to the estimated distance and the link condition between MRs.

This paper describes the design and the implementation of NEMO SHAKE and experiments we conducted on real vehicular networks. The rest of the paper is organized as follows. Section 2 gives an overview of NEMO and describes the design of NEMO SHAKE in detail. The implementation of NEMO SHAKE and

^{†1} Graduate School of Engineering, Shizuoka University

^{†2} Graduate School of Science and Technology, Shizuoka University

*1 Presently with Hitachi, Ltd.

experiments on real vehicular networks are presented in Section 3. Section 4 discusses related work and Section 5 summarizes the paper.

2. NEMO SHAKE

In this section, we firstly give the overview of NEMO which is the base of NEMO. We then explain NEMO SHAKE in details.

2.1 Network Mobility (NEMO)

NEMO Basic Support provides connectivity to the Internet regardless of the movement of mobile networks that are working on means of transport such as vehicles and trains. When an MR receives a care-of address (CoA) that is an IP address used in the external network, it registers its home address (HoA) that is an IP address used in its home network, the CoA, and its Mobile Network Prefix (MNP) with a Home Agent (HA). The message used for registration is called a *Binding Update* (BU). The HA sets the HoA as the next hop address of the MNP in its routing table and keeps the binding of the HoA and the CoA in a cache called a *Binding Cache*. The HA also sends a *Binding Acknowledgement* (BAck) to the MR as a reply message when the registration has finished. The MR and the HA establish a bi-directional tunnel between them. The tunnel is used to transmit packets between the MNNs and their correspondent nodes (CNs) on the Internet. Therefore, each MNN can always communicate using the same IP address.

2.2 NEMO SHAKE

NEMO SHAKE is an architecture combining SHAKE with NEMO. It constructs an alliance between MRs on different mobile networks. When an MNN connected to an MR in an alliance communicates with a CN, the MR simultaneously uses multiple external links of MRs in the alliance to provide a high-speed and reliable communication with the MNN. NEMO SHAKE introduces the following functional entities. An alliance leader router (ALR) is an MR in the alliance that communicates by using the multiple external links of MRs. Alliance member routers (AMRs) are other MRs in the alliance that forward traffic between the ALR and the CN. A traffic distribution mechanism is integrated into the ALR and its HA that supports NEMO, because IP packets from a CN to an MNN connected to the ALR are routed to the HA. **Figure 1** has an overview of

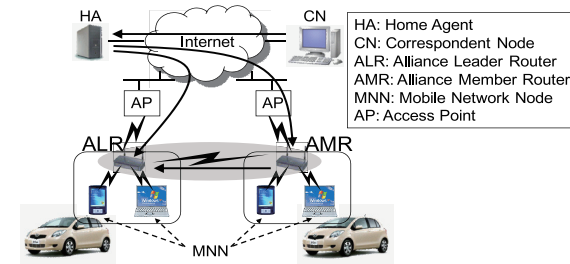

Fig. 1 NEMO SHAKE.

NEMO SHAKE. Note that each MR can act as both ALR and AMR if its HA supports NEMO SHAKE. Thus, if the right MR (tagged as AMR) in Fig. 1 acts as ALR, MNNs under the MR can use the external link of the left MR.

2.2.1 Making an Alliance of MRs

The destination, the speed of movement, and the direction of vehicles that carry MRs in the alliance are generally different. The connectivity between an ALR and its AMRs may be lost during multiple-path communication by using NEMO SHAKE and packets distributed to the AMRs may also be lost. It is therefore important for the ALR to prevent loss of packets distributed to the AMRs by stopping the distribution of traffic to the AMRs before the link is disconnected between the ALR and the AMRs. The ALR should also select AMRs from MRs that have stable links to maintain stable communications and construct an alliance with the AMRs.

Figure 2 outlines the procedure for constructing an alliance. To find AMR candidates for the ALR, the ALR periodically broadcasts a message called an alliance request (AReq) from the interface that can communicate with MRs. The AReq message includes the ALR's HoA, its CoA, an address of its HA, and its local address for the interface that can communicate with MRs. If an MR receives an AReq message and decides to participate in the alliance, it sends a reply message called an alliance reply (ARep) to the ALR. The ARep message includes the MR's positional information and resource information (bandwidth of external link, Received Signal Strength Indicator (RSSI) of the ALR observed by the MR, and the number of other alliances in which the MR participates)

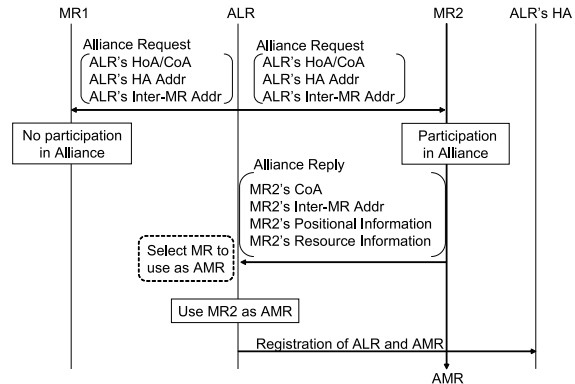

Fig. 2 Procedure to construct Alliance.

in addition to the MR's CoA and its local address for the interface that can communicate with MRs. The positional information includes the coordinate of the MR provided by GPS, the speed of movement and the direction calculated by using the most recent coordinates of the MR.

The ALR undertakes a two-phase operation to construct an alliance with MRs that have stable wireless links (Fig. 3). MRs are selected in the first phase according to the positional information. The ALR calculates the current distance between vehicles that are carrying the ALR and an MR using GPS information on both the ALR and the MR. The ALR also estimates the distance between vehicles at $T_{connect}$ seconds later ($D(t + T_{connect})$). $T_{connect}$ is the minimum connection time for the alliance, and t is the current time. If $D(t + T_{connect})$ is less than the communication range between the ALR and the MR, the ALR selects the MR as an AMR candidate. $T_{connect}$ should be set up according to the coverage of the wireless LAN and the type of antenna.

Second, MRs are selected according to the communication conditions between MRs from the AMR candidates. The ALR selects MRs for which the difference of the bandwidth of their external links to the Internet is less than the threshold, the RSSI between MRs is more than the threshold, and the value of the bandwidth is in the top N s. N is the maximum number of MRs in an alliance. The thresholds for the bandwidth and the RSSI should be selected according to the environment.

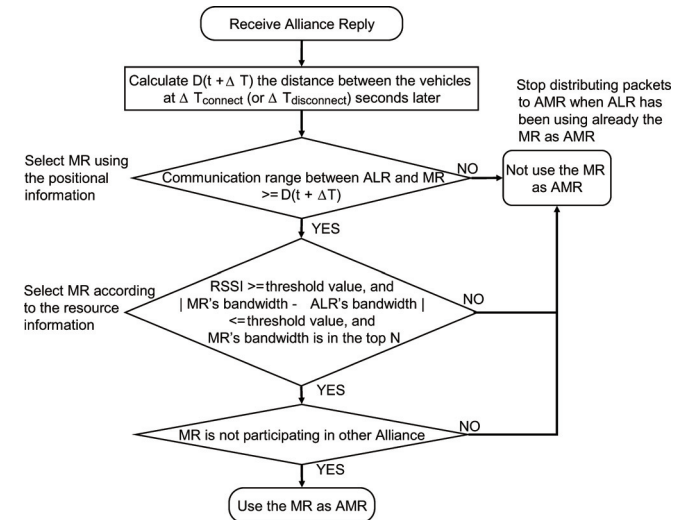

Fig. 3 Flowchart for selecting MRs to use as AMR.

The reason why the difference of bandwidth is used as one of the criterion for AMR selection is that it causes out-of-order packet arrivals. Out-of-order packet arrivals cause packet retransmissions and the shrinkage of the congestion window of TCP flows. If a smart algorithm for packet scheduling is used, out-of-order packet arrivals may be avoided. However, it is safe not to use AMRs which have a link with a significantly different bandwidth.

The ALR selects MRs that are not participating in other alliances from the MRs selected with the above procedures, and uses the MRs as AMRs. The ALR also manages the information on AMRs using an alliance member list (AML) and the AML sets the lifetimes for all AMR entries (Fig. 4).

If a malicious MR acts as AMR, packets forwarded to the AMR may be dropped or be used for eavesdropping. For avoiding such MRs to be included in an alliance, ALRs can optionally authenticate the candidate of AMRs. One practical solution for this purpose is the challenge-response authentication. Assume that an ALR and an AMR candidate share a passphrase issued by a group of MRs or a service provider. The ALR sends AReq with a timestamp and a random text. Then an

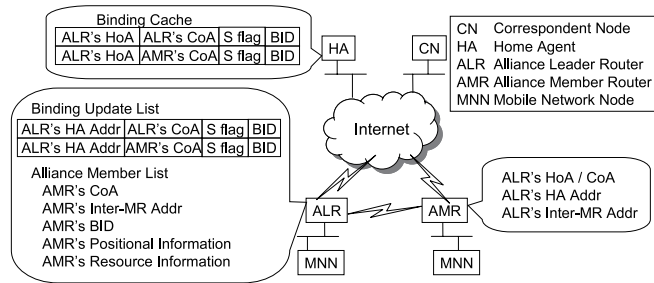

Fig. 4 Information that each node holds.

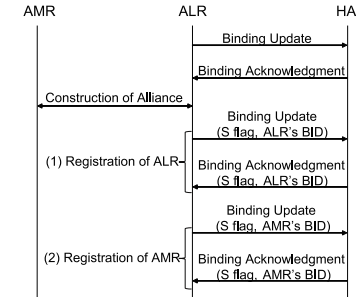

Fig. 5 Registration of CoA of MRs.

AMR candidate calculates the digest of a string consisting of the time stamp, the random text and the passphrase, and sends it to the ALR by piggybacking it to an ARep message. The ALR can authenticate the AMR candidate by comparing the received digest and the one calculated by the ALR itself.

For stopping traffic from being distributed to the AMR before the link between the ALR and the AMR is disconnected, the ALR must observe the connectivity between the ALR and AMR. The ALR regularly broadcasts AReq messages after constructing an alliance and it updates the AML. When the ALR updates the AML, the ALR recalculates $D(t + T_{\text{disconnect}})$. $T_{\text{disconnect}}$ is the minimum connection time to maintain the alliance. When $D(t + T_{\text{disconnect}})$ is outside the communication range between the ALR and the AMR, the ALR stops distributing traffic to the AMR and deletes the route information for the AMR. When the difference of bandwidth of the external link between the ALR and the AMR is more than the threshold and the RSSI between MRs is less than the threshold, the ALR also stops distributing traffic to the AMR and deletes the route information for the AMR.

2.2.2 Registration of Multiple Paths

In NEMO SHAKE, an ALR must register the CoAs of its AMRs as the CoAs of the ALR with the HA of the ALR to use the external links of the AMRs. The registration is done by the ALR to avoid malicious registrations by other MRs. All messages for registration are authenticated by IPsec as specified in the NEMO Basic Support. The NEMO Basic Support specification does not allow MRs to register multiple CoAs for an MR with a single HoA. Therefore, we assigned a

Binding Unique Identification number (BID)⁴⁾ to each CoA to distinguish CoAs of the ALR and AMRs. The ALR sends the HA BU messages to register the ALR and the AMRs. Each BU message has BID sub-options including each BID of the ALR and the AMRs. Also, the ALR adds a SHAKE (S) flag to each binding update in order to indicate NEMO SHAKE registration to the HA. The HA distinguishes each entry of the ALR and the AMRs by using the BIDs and holds their entries in the Binding Cache (Fig. 4). When each registration is completed, the HA sends the ALR a BACk as a reply. **Figure 5** illustrates the packet exchange sequence for the registration of the CoAs of MRs.

2.2.3 Communication Using NEMO SHAKE

Packets from CNs to MNNs (called downward communication) are distributed to the external link of an ALR and multiple external links of AMRs by the HA. Meanwhile, packets sent from the MNNs to the CNs (called upward communication) are distributed to the HA of the ALR and the AMRs by the ALR, which is a default router for the MNNs.

2.2.3.1 Downward Communication

When an HA receives packets from CNs to MNNs, it knows that the next hop address of the packets will be the HoA of the ALR from its routing table. The HA finds an entry for the HoA from the Binding Cache and encapsulates the packets destined for CoAs of the ALR and the AMRs. The HA also inserts a type 2 routing header to each packet. The home address field of the type 2 routing header includes the CoA of the ALR. If the AMR receives packets with

the type 2 routing header including the CoA of the ALR from the HA of the ALR, the AMR forwards the packets to the ALR through the link between the ALR and the AMR.

2.2.3.2 Upward Communication

When the ALR directly forwards the packets to the HA of the ALR, the ALR uses a bi-directional tunnel between the ALR and the HA according to the NEMO basic support protocol. Packets forwarded by way of the AMR are sent through multiple tunnels. When the ALR encapsulates a packet, it sets the source address field in the IPv6 header to the CoA of the AMR and the destination address field to the HA's address. Then, the ALR encapsulates the packet, and sets the destination address field in the outer IPv6 header of the packet to the AMR's local address for an interface that can communicate with MRs and the source address field to the ALR's local address. Due to this additional encapsulation, the total header length of the packet is 40 bytes longer than one of the original NEMO BS. The ALR forwards the packets to the AMR with the link between the ALR and the AMR. When the AMR receives the packets, it decapsulates the packets and forwards them to the HA of the ALR through its external link.

3. Performance Evaluation in Real Vehicular Networks

3.1 Implementation

We implemented NEMO SHAKE by extending SHISA⁵⁾ in the FreeBSD 5.4-release. Because the function of registering multiple CoAs is supported by SHISA, we registered multiple CoAs with the HA of the ALR by extending part of the function. We added AReq and ARep messages as part of the ICMPv6 protocol. In our implementation, an ALR selects MRs to use as AMRs according to the positional information on MRs and the RSSI between them. In addition, we used round robin as the distribution mechanism in the ALR and its HA. The authentication mechanism presented in Section 2.2.1 was not implemented.

3.2 Downward Communication

3.2.1 Experimental Environment

Figure 6 has an overview of the experimental environment for downward communication (from CN to MNN). We used two vehicles. The first vehicle had three mobile devices of ALR, a router (Router 2) and MNN. The second vehicle had

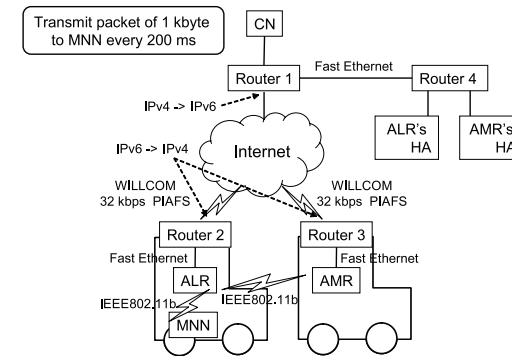

Fig. 6 Experimental network topology.

two mobile devices of AMR and a router (Router 3). We used 32-kbps PIAFS (PHS Internet Access Forum Standard) links provided by WILLCOM as the external links for Routers 2 and 3 to connect the MRs to the Internet. Even though NEMO SHAKE was designed on IPv6, PHS networks only work for IPv4. Therefore, we used IPv6 over IPv4 tunnel to connect Routers 1 and 2 and to connect Routers 1 and 3. For that reason, the MRs were not connected to the Internet directly and only connected to the Internet by the tunneling router (Routers 2 and 3). When the vehicle stops, the average RTT between MNN on the car and CN obtained by 30 ping operations using 64 bytes data packets was 467 ms. We used IEEE 802.11b to connect the MRs and the MNN. We used channels 11 and 6 of the wireless LANs. The transmission rate for the wireless LANs was selected automatically and we used external antennas for these. **Figure 7** shows a picture of the devices used in the experiment.

3.2.2 Experiment 1: Parked and Moving Vehicles

We only moved one of the vehicles in the first experiment to test the basic behavior of the alliance-control mechanism. The vehicle that carried the ALR (called the ALR-car) was stationary and the vehicle that carried the AMR (called the AMR-car) moved slowly. We tested and confirmed the basic efficiency of NEMO SHAKE and the transition between single-path and multiple-path modes.

3.2.2.1 Experiment Procedure

We conducted the experiment in the parking area of a supermarket in the city

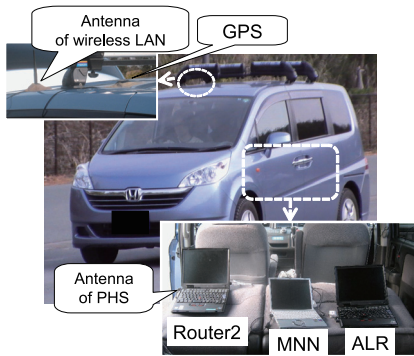

Fig. 7 Devices used in Experiments.

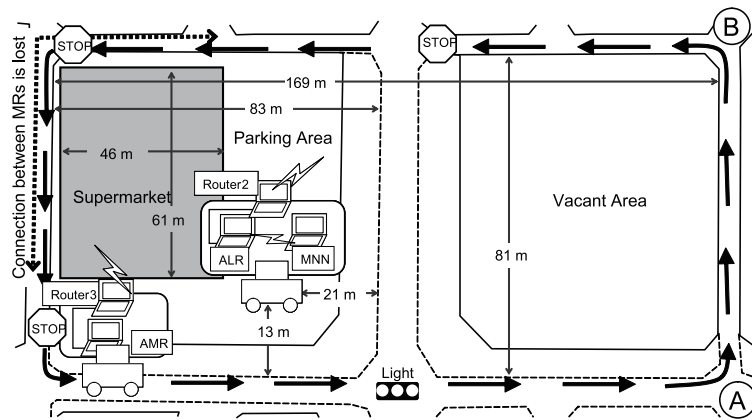

Fig. 8 Vehicle movement scenario in Experiment 1.

of Hamamatsu. **Figure 8** shows the scenario for the movement of one of the vehicles. The ALR-car was stationary at the position shown in Fig. 8 and the AMR-car moved around it from the initial position at a speed of about 20 km/h. The communication range between the MRs was about 200 m when we used the external antenna; however, we set the threshold of the communication range between the MRs at 100 m to confirm the transition between single-path and multiple-path modes. We also set $T_{connect}$ at 20 s and $T_{disconnect}$ at 5 s. Under

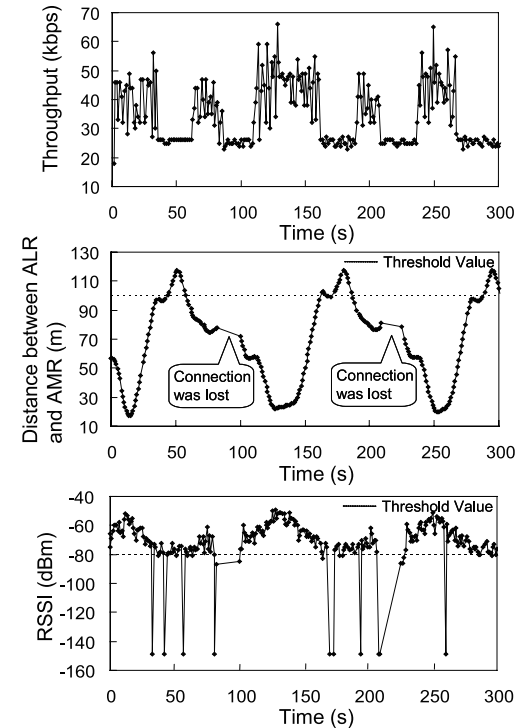

Fig. 9 Throughput, distance between ALR and AMR, and RSSI in Experiment 1.

these conditions, the CN sent UDP packets of 1 kbyte to the MNN every 200 ms and we measured the throughput. We set the threshold of RSSI at -80 dBm in this experiment, the sending interval of the AReq message at 1 s, and the entry lifetime of the AML at 5 s.

3.2.2.2 Results

Figure 9 shows the measured throughput at the MNN. We repeated the same trial more than 10 times and confirmed the transition had occurred between the single-path and the multiple-path modes in all trials.

Immediately after we started the experiment, the ALR made the transition from the single-path to the multiple-path mode. This is because the distance between the ALR-car and the AMR-car at $T_{connect}$ seconds later was less than the

Table 1 Number of lost packets due to disconnection between MRs.

Timing when ALR stopped distributing packets to AMR	Number of lost packets (first, second)
Before the disconnection	(12, 17)
After the disconnection	(34, 40)

threshold of the communication range and the RSSI between the MRs was more than the threshold. As a result, the throughput increased from 18 to 46 kbps. 30 s after making the transition to the multiple-path mode (before the AMR-car turned left at corner A in Fig. 8), the ALR made the transition from the multiple-path to the single-path mode. This is because the distance between the vehicles at $T_{\text{disconnect}}$ seconds later was larger than the threshold of the communication range even though the RSSI between the MRs was more than the threshold.

Then the AMR-car turned left at corner B in Fig. 8, and 59 s after the start of the experiment, the ALR made the transition from the single-path to the multiple-path mode again. However, 1 s later, the ALR made the transition from the multiple-path to the single-path mode because the RSSI between the MRs was smaller than the threshold. The ALR repeatedly made the transition between single-path and multiple-path modes within several seconds. After that, the ALR shifted to the single-path mode and the multiple-path mode according to the distance between the vehicles and the RSSI between the MRs.

The connectivity between MRs was lost due to obstacles (supermarket buildings) at periods from 82 s to 100 s and from 209 s to 225 s. The ALR changed the mode from the multiple-path to the single-path mode according to the threshold of the RSSI before the connectivity between the MRs was lost to avoid packet losses due to the lost connectivity. However, even with this function, 12 packets were lost during the first period of disconnection and 17 were lost during the second (Table 1). These packets were sent before the distribution of packets from the HA to the AMR was stopped due to the mode change of the ALR from the multiple-path to the single-path mode. After these packets arrived at the AMR, they were not forwarded to the ALR because the connectivity between the AMR and the ALR was lost.

To verify the effect of the mode transition according to the RSSI of the link between MRs, we conducted another trial by disabling the function. In this

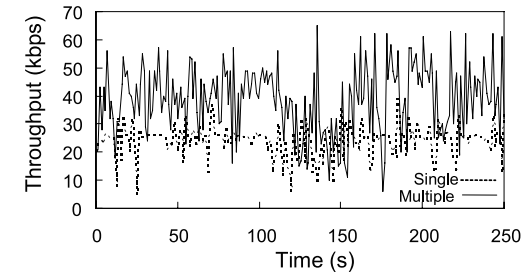
**Fig. 10** Throughput in Experiment 2.

trial, the ALR stayed in the multiple-path mode until the binding of AMR's CoA expired even if the connectivity between MRs was lost. The number of lost packets in this trial was larger than the previous case. 34 packets and 40 packets were lost due to the two periods of disconnection. From these results, we can conclude that it is useful to stop distributing packets to the AMR before connectivity between MRs is lost for avoiding packet losses.

3.2.3 Experiment 2: Two Moving Vehicles

We carried out the experiment on public roads in the city of Hamamatsu using two vehicles moving at a maximum speed of 40 km/h. The AMR-car always followed the ALR-car. We used the same parameters as those in Experiment 1.

Figure 10 shows the measured throughput where the ALR used the single-path and multiple-path modes at all times. The average throughput by using the multiple-path mode was about 38.8 kbps, which was about 1.64 times that of the single-path mode. However, there were places where the throughput was low regardless of the multiple-path mode because the PHS link was not stable in these locations.

3.3 Upward Communication

3.3.1 Experimental Environment and Procedure

For the experiment of upward communication (from MNN to CN), we used the same experimental environment as that in Section 3.2. However, we did not use the vehicles, and carried out this experiment on foot. Though we tried to conduct the experiment with vehicles, we found a severe problem in the results of the walking scenario which is softer than the vehicle scenario. Thus we did

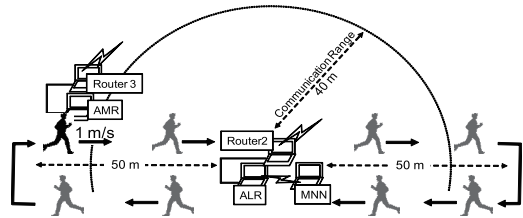

Fig. 11 Movement scenario for upward communication experiment (Walking Scenario).

not conduct the experiment with vehicles, and focus on discussing the problem in the next section.

In the walking scenario, three mobile devices of ALR, Router 2 and MNN were fixed and a person having two mobile devices of AMR and Router 3 moved at a speed of about 1 m/s. Figure 11 shows the scenario. We set the threshold of the communication range between the MRs at 40 m in this experiment. The other parameters we used were the same as Section 3.2 and the MNN sent UDP packets of 1 kbytes to the CN every 200 ms.

3.3.2 Results

Figure 12 shows the measured throughput at the CN. 19s after we started the experiment, the ALR sent the HA a BU for registering the AMR because the distance between the ALR and the AMR at $T_{connect}$ seconds later was less than the threshold of the communication range and the RSSI between the MRs was more than the threshold. 9s after sending the BU, the ALR received a BACK from the HA to indicate the completion of the AMR’s registration and made the transition to the multiple-path mode. As a result, the ALR started distributing packets to the HA and the AMR, and the throughput increased from 25 to 39 kbps. 31s after making the transition to the multiple-path mode, the ALR sent the HA a BU to delete the AMR’s registration because the RSSI between the MRs was smaller than the threshold. The ALR stopped distributing the packets to the AMR and made the transition from the multiple-path to the single-path mode.

The ALR could not make a transition to the multiple-path mode at a period from 230s to 300s though the AMR moved within the threshold of the communication range between the ALR and the AMR. This is because the BU for

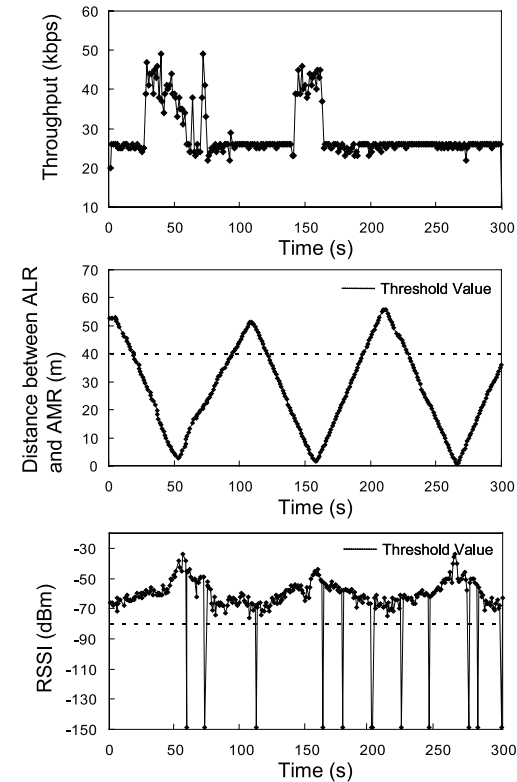

Fig. 12 Throughput, distance between ALR and AMR, and RSSI in upward communication experiment.

registering the AMR was lost on the PHS link of the ALR and the link delay of PHS was large. When the BU was lost, the ALR resent the BU triggered by the retransmission timeout. Thus, the arrival of the BU at the HA was late. Even if the BU was not lost, it might take a long time for the BU arriving at the HA due to the long PHS link delay. We measured the round trip time (RTT) between a MNN connected to the ALR and the CN when all MRs did not move. The average RTT with 30 ping trials using 64 byte-length IP-payload was 467 ms.

The ALR could not make the transition to the multiple-path mode until re-

ceiving a BACK the HA sent. Additionally, if the ALR made a transition between single-path and multiple-path modes according to the distance and the RSSI while awaiting the arrival of the BACK, the ALR would send a lot of BUs to register or delete the entry of the AMR. It would take a much longer time until receiving the BACK. For these reasons, the ALR could not receive the BACK while the AMR moved within the threshold of the communication range and make the transition to the multiple-path mode.

3.4 Observation and Discussion

When an ALR wants to use the external links of multiple MRs in upward communication, it takes a long time to make the transition from the single-path to the multiple-path mode. This is because the ALR cannot receive a BACK before the retransmission timeout of a BU due to the delay the sending interface of the external link has. In the worst case, even if there is a MR which the ALR can use as an AMR, the ALR cannot make the transition to multiple-path mode.

In our experiment, we avoided redundant retransmissions of BUs by increasing the duration of the retransmission timer so that the ALR could receive the BACK before the retransmission timeout of the BU. However, if the ALR cannot receive the BACK and sends a lot of BUs triggered by a retransmission timeout, the ALR may decide that the connectivity between the ALR and the HA is lost. In fact, we confirmed such a case and the communication between the MNN and the CN was lost. Meanwhile, when making the transition from the multiple-path to the single-path mode, the ALR sends a BU to delete an AMR's entry. At the same time, the ALR stops distributing packets to the AMR. Though it takes a short time to make the transition to the single-path mode, unnecessary BUs may be sent multiple times.

On the other hand, in downward communication, the arrival of the BACK may be late because of the long delay of the ALR's external link. When ALR's HA receives a BU for registering an AMR, the HA starts distributing packets to the ALR and the AMR. When the HA receives a BU to delete the entry of the AMR, the HA stops distributing. Thus, it will require only a short period to make the transition between the single-path and multiple-path modes. However, if not only downward packets but also upward packets are sent, the arrival of the BU at the HA will be late due to the delay of the ALR's external link. It takes

a much longer time to make the transition from the single-path to the multiple-path mode even for the downward communication. Additionally, if the arrival of a BU for deleting the entry of the AMR is late and the BU arrives at the HA after losing the connectivity between the ALR and the AMR, packets distributed from the HA to the AMR will be lost. One solution for this problem is to give a high priority to control packets such as BUs and BACKs.

To take full advantage of NEMO SHAKE, the connectivity of the wireless LAN links between an AMR and AMRs has to be kept for a long time. On urban congested roads, finding AMRs which have good connectivity to the ALR will not be difficult. If taxis and busses support NEMO SHAKE, they and other vehicles would be easy to use NEMO SHAKE. In uncongested areas, it will be practical to use NEMO SHKE with members in a group that goes to the same destination.

How many AMRs can be used in NEMO SHAKE? Clearly, the effective bandwidth of the link connecting MRs has to be larger than the sum of bandwidth of external links of the ALR and AMRs. Using more AMRs increases the risk of packet losses on links between the ALR and AMRs, and between the internet and the MRs, because all MRs are moving. Even though NEMO SHAKE has the function for avoiding packet losses due to disconnections of links between the ALR and AMRs as stated in Section 2.2.1, it cannot avoid the effect of sudden disconnections of those links. If the link between the ALR and a AMR is disconnected, a portion of packets are forwarded to the AMR and discarded by the AMR until the ALR unregister the CoA of the AMR from the HA after detecting the disconnection, because the HA does not know the disconnection between the ALR and AMR. If multiple AMRs are used, the risk of such continuous packet losses becomes large. The effect of such losses will be more serious if TCP is used because packet losses reduce the size of the congestion window to the minimum value, e.g., 1 maximum segment size, then the transmission rate becomes very small. Thus, assuming an unpredictable disconnection occurs once per several minutes, the practical number of AMRs in an alliance will be one or two. If the number of AMRs is large, the overhead of signaling messages (BU, AReq and ARep) will be not negligible. The effect, however, will be small compared with the risk of packet losses caused by an unpredicted disconnection of the link

between the ALR and AMRs.

4. Related Work

When MRs communicate with hosts on the Internet, they suffer from a scarcity of bandwidth and disconnections of external links. If the MRs simultaneously utilize multiple network interfaces and have multiple paths to the Internet, these issues can be alleviated⁶⁾. This section introduces some studies where MRs have simultaneously utilized multiple paths to improve the transmission speed and the reliability of the connectivity to the Internet^{7)–9)}.

Imai, et al. proposed a system that utilized multiple-network interfaces that were equipped with a single MR and that could increase the bandwidth of external links⁷⁾. Tsukada, et al. assumed that a single mobile network had multiple MRs and proposed a system that simultaneously utilized the multiple external links of MRs⁸⁾. Charbon, et al. have evaluated various scenario of NEMO Basic support for supporting various Multi-homing scenarios⁹⁾. The scenarios include a case where a MR has multiple network interfaces and a case where multiple MRs are connected to a mobile network. The former is similar to Ref. 7) and the latter to Ref. 8). Even though these systems utilize multiple external links, the mobile network may lose the connectivity to the Internet if the multiple links are disconnected due to the geographical position of the host carrying the MR(s) or obstacles. This is because the connectivity to the Internet relied on MR(s) on a single host.

Tsukada, et al. proposed a system which combines Mobile Ad-hoc Network (MANET) which constructs a network without depending on any infrastructure and NEMO, called MANEMO¹⁰⁾. This system is used for communication between vehicles which carries an MR and the MR is equipped with multiple network interfaces. The MR uses NEMO route and MANET route together, and can improve the transmission speed. However, if CNs of MNNs are hosts in the Internet, the MR can not use the MANET route.

In the NEMO SHAKE we designed, MRs carried by different vehicles share the external links of the MRs with one another. Therefore, NEMO SHAKE can provide a connection to the Internet with an MR by using the external links of other MRs in an alliance even if an external link of a single mobile network is

unavailable. NEMO SHAKE also has an advantage in that not all MRs have to have multiple external links.

5. Conclusion

We designed and implemented NEMO SHAKE that constructs an alliance between MRs on different vehicles and simultaneously uses multiple external links of MRs in an alliance. We also implemented a system to control alliances that increases the bandwidth and the stability of links between vehicles and the Internet by estimating the distance and the link condition between MRs. We evaluated the performance of NEMO SHAKE and the alliance-control system in real vehicular networks. We tested and confirmed that the transition between single-path and multiple-path modes by the alliance-control system could increase the bandwidth and the stability of communications between a vehicle and the Internet. The average throughput in the multiple-path mode was about 1.64 times that in the single-path mode. We also evaluated the performance of upward communication. We confirmed the increase of throughput in the multiple-path mode. However, sometimes an ALR could not make the transition from the single-path to the multiple-path due to the loss of the control packets. For improving the robustness of the system, assigning a high priority to NEMO control packets would be useful.

We also evaluated the performance of NEMO SHAKE with external links of HSDPA 3.5G mobile communication link, and confirmed the increase of throughput by using multiple external links in both upward and downward communication. However, the throughput sometimes did not increase or was smaller than the single-path mode regardless of using the multiple-path mode. This is because, multiple devices share the same wireless band and select a modulation method such as QPSK and 16 QAM according to the signal condition in HSPDA. For this type of external links, using the best quality link of MRs in an alliance instead of using all external links in the same alliance will be useful.

References

- 1) Koyama, K., Ito, Y., Mineno, H. and Ishihara, S.: Evaluation of Performance TCP on Mobile IP SHAKE, *IPSSJ Journal*, Vol.45, No.10, pp.2270–2278 (2004).

- 2) Ogi, K., Masuda, T., Mineno, H. and Ishihara, S.: Design and implementation of mobility mechanisms for mobile IPv6 based Link aggregation system, *Proc. SAINT2005 Workshops, IPv6 Deployment Status and Challenges Workshop*, pp.72–75 (2005).
- 3) Devarapalli, V., Wakikawa, R., Petrescu, A. and Thubert, P.: Network Mobility (NEMO) Basic Support Protocol, RFC 3963 (2005).
- 4) Wakikawa, R., Devarapalli, V., Tsirtsis, G., Ernst, T. and Nagami, K.: Multiple Care-of Address Registration, RFC 5648 (2009).
- 5) Shima, K., Koshiro, M., Wakikawa, R., Momose, T. and Uehara, K.: SHISA: The mobile IPv6/NEMO BS Stack Implementation Current Status, *Proc. Asia BSD Conference 2007* (2007).
- 6) Ernst, T., Montavont, N., Wakikawa, R., Ng, C. and Kuladinithi, K.: Motivations and Scenarios for Using Multiple Interfaces and Global Addresses, Internet Draft (draft-ietf-monami6-multihoming-motivation-scenario-03) (2008).
- 7) Imai, N., Isomura, M. and Horiuchi, H.: Inverse-Multiplexing for Mobile Routers with Multiple Wireless Network Interfaces, *Proc. The 1st International Workshop on Network Mobility (WONEMO 2006)* (2006).
- 8) Tsukada, M., Ernst, T., Wakikawa, R. and Mitsuya, K.: Dynamic Management of Multiple Mobile Routers, *Proc. IEEE Malaysia International Conference on Communications and IEEE International Conference on Networks (MICC & ICOIN 2005)*, Vol.2, pp.1108–1113 (2005).
- 9) Charbon, J., Ng, C.-W., Mitsuya, K. and Ernst, T.: Evaluating multi-homing support in NEMO Basic solution, Internet Draft (draft-charbon-nemo-multi-homing-evaluation-00) (2003).
- 10) Tsukada, M., Mehani, O. and Ernst, T.: Simultaneous Usage of NEMO and MANET for Vehicular Communication, *Proc. 1st Workshop on Experimental Evaluation and Deployment Experiences on Vehicular Networks (WEEDEV)* (2008).

(Received March 31, 2010)

(Accepted October 4, 2010)

(Released January 12, 2011)



Kei Tanimoto was born in Yamaguchi, Japan in 1986. He received his B.E. and M.E. degrees from Shizuoka University in 2008 and 2010. Since 2010, he has been working for Hitachi, Ltd. His research interests are in the areas of mobile TCP/IP networking and mobile ad hoc networking. He is a member of IPSJ.



Susumu Ishihara was born in Gifu, Japan in 1972. He received his B.E., M.E, and Ph.D. degrees in Electronic Engineering from Nagoya University in 1994 and 1999. From 1998 to 1999 he was a JSPS Special Researcher. Since 1999, he has been with Shizuoka University, where he is an associate professor of the Graduate School of Science and Technology. He was a visiting researcher at the University of California, Irvine in 2008. His research interests are in the areas of mobile TCP/IP networking, mobile ad hoc networking and sensor networks. He is a member of IEEE, IEEE Communication Society, IEEE Computer Society, ACM SIGMOBILE, ACM SIGCOMM, IEICE, and IPSJ.